

**BU 0830 – en**

**Functional Safety**

Supplemental manual for series SK 300P





## Read document and keep for future reference

---

Read this document carefully prior to performing any work on or putting the device into operation. It is essential to read and observe the instructions in this document. They serve as the prerequisite for smooth and safe operation and the fulfilment of any warranty claims.

Contact Getriebebau NORD GmbH & Co. KG if your questions regarding the handling of the device are not answered in this document or if you require further information.

The German version of this document is the original. The German document is always decisive. If this document is available in other languages, this will be a translation of the original document.

Keep this document in the vicinity of the device so that it is available if required.

For any installation work, please always use the latest version of this documentation. It can be found under [www.nord.com](http://www.nord.com).

Please also note the following documents:

- Documentation for the frequency inverter
- Documentation for optional accessories
- Documentation for equipment which is attached or provided.

Please contact [Getriebebau NORD GmbH & Co. KG](http://www.nord.com) if you require further information.



## Table of Contents

<b>1</b>	<b>Introduction .....</b>	<b>6</b>
1.1	General .....	6
1.1.1	Documentation .....	6
1.1.2	Document history .....	6
1.1.3	About this manual .....	7
1.2	Other applicable documents .....	7
1.3	Presentation conventions .....	7
1.3.1	Warning information .....	7
1.3.2	Other information .....	7
1.3.3	Text markings .....	8
1.4	Safety, installation and application information .....	8
<b>2</b>	<b>Function description .....</b>	<b>12</b>
2.1	Design of the safe shut-down method .....	12
2.1.1	Safe Pulse Block .....	13
2.1.2	Safety Digital Input .....	13
2.2	Safety functions .....	14
2.2.1	Safe Torque Off, STO .....	14
2.2.2	Safe Stop 1 time-controlled, SS1-t .....	14
2.2.3	Priorities and response to faults .....	15
2.3	Examples / Implementation .....	16
2.3.1	STO function .....	16
2.3.2	SS1-t function .....	18
2.3.3	Simple re-start block .....	19
2.3.4	Example without Safe Pulse Block .....	20
2.3.5	Exclusion of wiring faults .....	21
<b>3</b>	<b>Assembly and installation .....</b>	<b>22</b>
3.1	Installation and assembly .....	22
3.2	Electrical connection .....	22
3.2.1	Mains connection .....	22
3.2.2	Control cable connections .....	23
3.2.3	Details on control terminals .....	24
3.3	Details of the safe shut-down method .....	24
3.3.1	Wiring and shielding .....	24
3.3.2	Operation with OSSD .....	24
3.3.2.1	Individual operation .....	25
3.3.2.2	Multiple device operation .....	27
3.3.3	EMC .....	28
<b>4</b>	<b>Commissioning .....</b>	<b>29</b>
4.1	Commissioning steps for STO .....	29
4.2	SS1-t commissioning steps .....	29
4.3	Validation .....	32
<b>5</b>	<b>Parameters .....</b>	<b>33</b>
5.1	Parameterisation .....	33
5.2	Description of parameters .....	33
5.2.1	Explanation of parameter description .....	34
5.2.2	Control terminals .....	35
5.2.3	Additional parameters .....	39
<b>6</b>	<b>Operating status messages .....</b>	<b>40</b>
<b>7</b>	<b>Additional information .....</b>	<b>42</b>
7.1	Protective switching devices .....	42
7.1.1	Output voltage of the protective switching devices .....	42
7.1.2	Switching capacity and current load .....	42
7.1.3	OSSD outputs, test pulses .....	44
7.2	Safety categories .....	45
7.2.1	IEC 60204-1:2016 .....	45
7.2.2	IEC 61800-5-2:2016 .....	45
7.2.3	IEC 61508:2010 .....	45

---

	7.2.4 ISO 13849-1:2015 .....	46
<b>8</b>	<b>Technical Data</b> .....	<b>47</b>
	8.1 Safe Pulse Block and Safety Digital Input .....	47
<b>9</b>	<b>Appendix</b> .....	<b>49</b>
	9.1 Maintenance information .....	49
	9.2 Repair information .....	49
	9.3 Service and commissioning information .....	50
	9.4 Documents and software .....	50
	9.5 Abbreviations .....	51

# 1 Introduction

## 1.1 General

### 1.1.1 Documentation

Designation:	<b>BU 0830</b>
Part number:	<b>6078302</b>
Series:	<b>Functional safety for frequency inverters from the series</b>
	<b>NORDAC ON</b> SK 301P
	<b>NORDAC ON+</b> SK 311P
Scope of application:	<ul style="list-style-type: none"> <li>• Frequency inverters with integrated safety inputs: SK 301P, SK 311P</li> <li>• From NORDAC ON software version V1.2R5</li> </ul>

### 1.1.2 Document history

<b>Edition</b>	<b>Series</b>	<b>Software version</b>	<b>Remarks</b>
<b>Order number</b>			
<b>BU 0830</b> , October 2021 <b>6078302/ 4121</b>	SK 300P	V1.2R5	• First issue
<b>BU 0830</b> , May 2023 <b>6078302/ 1923</b>	SK 300P	V1.2R10	• Additions due to power extension for the device series

## 1.1.3 About this manual

This manual is intended to help you with the commissioning of the Safe Stop functions (STO or SS1-t) with a frequency inverter from Getriebebau NORD GmbH & Co. KG (NORD). It is intended for all qualified electricians who plan, install and set up corresponding drive solutions  1.4 "Safety, installation and application information". The information in this manual assumes that the qualified electricians who are entrusted with this work are familiar with the handling of electronic drive technology, in particular with NORD devices.

This manual only contains information and descriptions of the functional safety and additional information which is relevant for the functional safety of frequency inverters manufactured by Getriebebau NORD GmbH & Co. KG.

## 1.2 Other applicable documents

This document is only valid in combination with the operating instructions for the frequency inverter which is used. Safe commissioning of the drive application depends on the availability of the information contained in this document.. A list of the documents can be found in  Section 9.4 "Documents and software".

The necessary documents can be found under [www.nord.com](http://www.nord.com).

## 1.3 Presentation conventions

### 1.3.1 Warning information

Warning information for the safety of users are marked as follows:



 **DANGER**

This warning information warns of danger to persons that results in severe injuries or death.



 **WARNING**

This warning information warns of danger to persons that could result in severe injuries or death.



 **CAUTION**

This warning information warns of danger to persons that could usually result in moderate injuries.



**NOTICE**

This warning information warns of material damage.

### 1.3.2 Other information



 **Information**

This information shows tips and important information.

### 1.3.3 Text markings

The following markings are used to differentiate between various types of information:



#### Text

Type of information	Example	Marking
Instructions	1. 2.	Instructions for actions whose sequence must be complied with are numbered sequentially.
Bullet points	•	Bullet points are marked with a dot.
Parameters	<b>P850</b>	Parameters are indicated by the prefix "P", a three-digit number and bold type.
Arrays	[-01]	Elements of arrays are indicated by square brackets.
Factory settings	{ 0.0 }	Factory settings are indicated by curly brackets.
Software descriptions	<b>"Cancel"</b>	Menus, fields, buttons and tabs are indicated by quotation marks and bold type.

#### Numbers

Type of information	Example	Marking
Binary numbers	100001b	Binary numbers are indicated by the suffix "b"
Hexadecimal numbers	0000h	Hexadecimal numbers are indicated by the suffix "h"

#### Symbols used

Type of information	Example	Marking
Cross-reference	 Section 2 "Function description"	Internal cross-reference A mouse click on the text calls up the stated point in the document.
	 Supplementary manual	External cross-reference
Hyperlink	<a href="http://www.nord.com/">http://www.nord.com/</a>	References to external websites are indicated in blue and underlined. A mouse click calls up the website.

## 1.4 Safety, installation and application information

Before working on or with the device, please read the following safety instructions extremely carefully. Please pay attention to all other information from the device manual.

Non-compliance can result in serious or fatal injuries and damage to the device or its surroundings.

**These safety instructions must be kept in a safe place!**

### 1. General

Do not use defective devices or devices with defective or damaged housings or missing covers (e.g. blind plugs for cable glands). Otherwise, there is a risk of serious injury or death from electric shock or rupture of electrical components, e.g. high power capacitors.

Unauthorised removal of covers, improper use, incorrect installation or operation causes a risk of serious personal injury or material damage.

Depending on its protection class, the devices may have live, bare, moving or rotating parts or hot surfaces during operation.



The device is operated with hazardous voltage. Dangerous voltage may be present at the supply lines, contact strips and PCBs of all connecting terminals (e.g. mains input, motor connection), even if the device is not working or the motor is not rotating (e.g. caused by electronic disabling, jamming of the drive or a short circuit at the output terminals).

The device is not equipped with a master mains switch and is thus always live when connected to mains voltage. Voltages may therefore be connected to a connected motor at standstill.

A connected motor may also rotate if the drive is disconnected from the mains and possibly generate hazardous voltage.

If persons come into contact with dangerous voltage such as this, there is a risk of an electric shock, which can lead to serious or fatal injuries.

The device and any power plug connectors must not be disconnected while a voltage is applied to the device. Failure to comply with this may cause arcing, which in addition to the risk of injury, also may result in a risk of damage or destruction of the device.

The fact that the status LED or other indicators are not illuminated does not safely indicate that the device has been disconnected from the mains and is without voltage.

The heat sink and all other metal components may heat up to temperatures above 70 °C.

Touching these parts can result in local burns to the body parts concerned (cooling times and clearance from neighbouring components must be complied with).

All work on the device, e.g. transportation, installation, commissioning and maintenance work must be carried out by qualified personnel (observe IEC 364 or CENELEC HD 384 or DIN VDE 0100 and IEC 664 or DIN VDE 0110 and national accident prevention regulations). In particular, the general and regional installation and safety regulations for work on low-voltage systems (e.g. VDE) must be complied with, as must the regulations concerning correct use of tools and the use of personal protection equipment.

During all work on the device, take care that no foreign bodies, loose parts, moisture or dust enter or remain in the device (risk of short circuit, fire and corrosion).

With certain setting conditions, the device or the motor which is connected to it may start automatically when the mains are switched on. The machinery which it drives (press / chain hoist / roller / fan etc.) may then make an unexpected movement. This may cause various injuries, including to third parties.

Before switching on the mains, secure the danger area by warning and removing all persons from the danger area.

Further information can be found in this documentation.

## 2. Qualified specialist personnel

Within the meaning of this basic safety information, qualified specialist personnel are persons who are familiar with the installation, assembly, commissioning and operation of the product and who have the qualifications appropriate to their work.

In addition, the device and the accessories associated with it must only be installed and commissioned by a qualified electrician. A qualified electrician is a person who, because of his/her technical training and experience, has sufficient knowledge with regard to

- switching on, switching off, disconnection, earthing and labelling of electric circuits and devices,
- correct maintenance and use of protective devices according to specified safety standards.

### 3. Intended use – general

Frequency inverters are devices for industrial and commercial systems that are used to operate three-phase asynchronous motors with squirrel-cage rotors and Permanent Magnet Synchronous Motors – PMSM (IE4, IE5+). These motors must be suitable for operation with frequency inverters, other loads must not be connected to the devices.

The devices are components intended for installation in electrical systems or machines.

Technical data and information for connection conditions can be found on the rating plate and in the documentation, and must be complied with.

The devices may only be used for safety functions which are described and explicitly approved.

CE-labelled devices meet the requirements of the Low Voltage Directive 2014/35/EU. The stated harmonized standards for the devices are used in the declaration of conformity.

#### a. Supplement: Intended use within the European Union

When installed in machines, commissioning of the devices (i.e. commencement of proper use) is prohibited until it has been ensured that the machine fulfils the provisions of EC Directive 2006/42/EC (Machinery Directive); EN 60204-1 must also be complied with.

Commissioning (i.e. start of intended use) is only permitted if the EMC directive (2014/30/EU) is complied with.

#### b. Supplement: Intended use outside the European Union

The local conditions of the operator for the installation and commissioning of the device must be complied with at the usage location (see also “a. Supplement: Intended use within the European Union”).

#### *Transport, storage*

The information in the manual regarding transport, storage and correct handling must be complied with.

The permissible mechanical and climatic ambient conditions (see technical data in the manual for the device) must be complied with.

If necessary, suitable, adequately dimensioned means of transport (e.g. lifting gear, rope guides) must be used.

#### *Installation and assembly*

The installation and cooling of the device must be implemented according to the regulations in the corresponding documentation. The permissible mechanical and climatic ambient conditions (see technical data in the manual for the device) must be complied with.

The device must be protected against impermissible loads. In particular, components must not be deformed and/or insulation distances must not be changed. Touching of electronic components and contacts must be avoided.

The device and its optional modules contain electrostatically sensitive components, which can be easily damaged by incorrect handling. Electrical components must not be mechanically damaged or destroyed.

#### *Electrical connection*

Ensure that the device and the motor are specified for the correct supply voltage.

Installation, maintenance and repair work must not be carried out unless the device has been disconnected from the voltage and at least 5 minutes have elapsed since the mains was switched off! (Due to charged capacitors, hazardous voltages may be present on the device for up to 5 minutes after being switched off from the mains). Before starting work it is essential to check by measurement that all contacts of the power plug connections or the connection terminals are voltage-free.

The electrical installation must be implemented according to the applicable regulations (e.g. cable cross-section, fuses, earth lead connections). Further instructions can be found in the documentation or manual for the device.

Information regarding EMC-compliant installations such as shielding, earthing, location of filters and routing of cables can be found in the documentation for the devices and in the technical information manual [TI 80-0011](#). This information must always be observed even with devices with a CE label. Compliance with the limit values specified in the EMC regulations is the responsibility of the manufacturer of the system or machine.

In case of a fault, inadequate earthing may result in electric shock, possibly with fatal consequences.

The device may only be operated with effective earth connections which comply with local regulations for large leakage currents (> 3.5 mA). Detailed information regarding connections and operating conditions can be obtained from the technical Information manual [TI 80-0019](#).

Connection of the supply voltage may directly or indirectly set the device into operation. Contact with electrically live components may result in electric shock, possibly with fatal consequences.

All poles of cable connections (e.g. power supply) must always be disconnected.

#### *Operation*

Where necessary, systems in which the devices are installed must be equipped with additional monitoring and protective equipment according to the applicable safety requirements (e.g. legislation concerning technical equipment, accident prevention regulations, etc.).

All covers must be kept closed during operation.

The PDS (SR) may suffer interference if mobile radio devices are used within a distance of less than 20 cm from the PDS (SR).

#### *Maintenance, repair and decommissioning*

Installation, maintenance and repair work must not be carried out unless the device has been disconnected from the voltage and at least 5 minutes have elapsed since the mains was switched off! (Due to charged capacitors, hazardous voltages may be present on the device for up to 5 minutes after being switched off from the mains). Before starting the work, it is essential to check by measurement that all contacts of the power plug connectors or the connection terminals are voltage-free.

#### **4. Potentially explosive environment (ATEX)**

The device is not approved for operation or maintenance work in potentially explosive environments (ATEX).

## 2 Function description

To prevent danger to people and material it is necessary to be able to safely switch off machines. The frequency inverters stated in this document provide safe shut-down methods.

The following basic explanation of the function of a frequency inverter serves to provide better understanding of the function of safe shut-down methods:

The mains voltages are rectified and the resulting DC links circuit voltage is reconverted to AC according to the requirements of the operating status of the motor (frequency and voltage).

The inverter's semiconductor switches (T1 to T6) are controlled by a complex pulse pattern. This pulse pattern is generated by the micro-controller ( $\mu\text{C}$ ) and amplified by the driver. The driver takes over the conversion of the logic signals to the control voltages of the semiconductor switches. The semiconductor switches are switched via the control voltage and the pulse pattern is amplified and applied to the motor terminals. Due to the low-pass effect of the motor, a three-phase pulse width modulated sine wave voltage, a three-phase system, results from the pulsed voltage. The motor generates a torque.

### 2.1 Design of the safe shut-down method

#### Structure of Safe Pulse Block

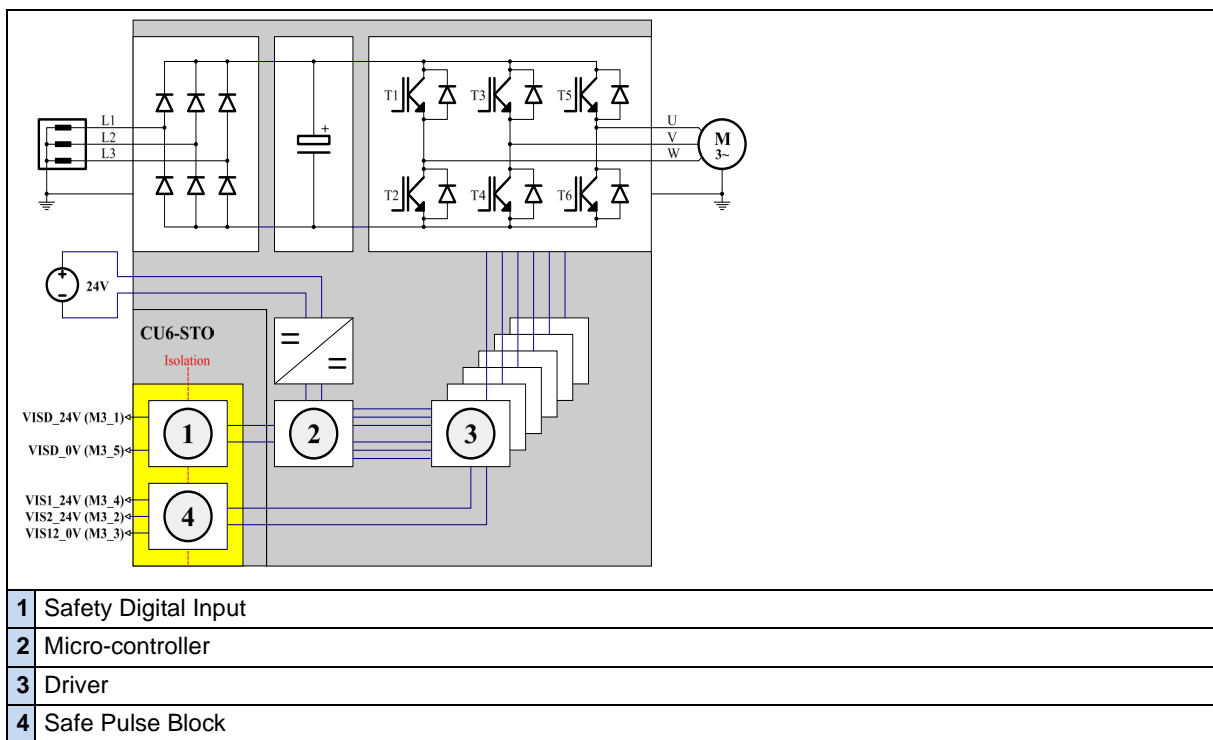

The SK 3xxP series frequency inverter can be ordered as SK 301P and SK 311P versions from size 2 onwards.

With these versions, the STO (safe torque off) and SS1-t (safe stop1 time controlled) stop functions can be implemented. The stop functions reach different maximum safety and performance levels (SIL/PL levels). A simple re-start block can also be implemented.

### 2.1.1 Safe Pulse Block

With the aid of an additional DC/DC converter, the Safe Pulse Block generates the supply voltage for the drivers. For this, the “Safe Pulse Block” must be provided with two 24 V voltages. This must be provided as follows:

- 2 x 24 V via contacts **VIS1\_24V** and **VIS2\_24V** with common reference potential **VIS12\_0V**

If these 24 V voltages are switched off, the DC/DC converter does not transmit any power to the drivers. As the drivers are now no longer supplied with power, no pulses reach the semiconductor switches (T1 to T6) of the inverter. The flow of current in the semiconductor switches and in the motor is interrupted. I.e. after a certain response time of the electronics and the reduction of the motor current, the motor does not develop a driving torque.

Switch-off of the 24 V voltages must be performed by a fail-safe switching device.

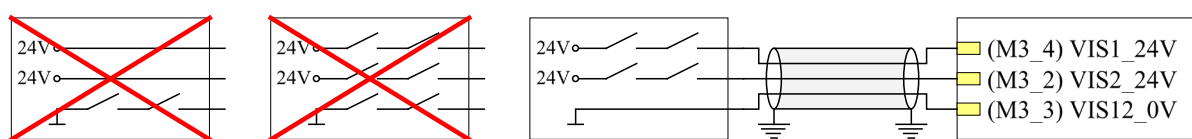

Contacts **VIS1\_24V** and **VIS2\_24V** have a common reference potential **VIS12\_0V**. This reference potential must not be disconnected if a dual-channel Safe Pulse Block is used.

The Safe Pulse Block can be used with a single channel. I.e. the two contacts **VIS1\_24V** and **VIS2\_24V** are connected in parallel.

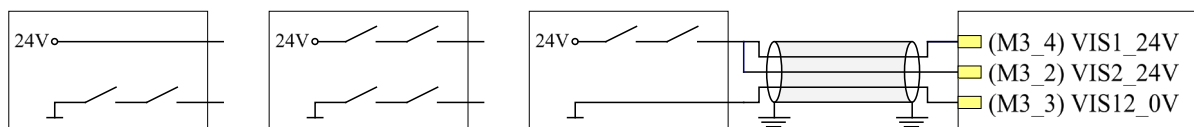

In this case, both the 24 V voltage as well as the reference potential **VIS12\_0V** can be disconnected. Preferably, the parallel contacts **VIS1\_24V** and **VIS2\_24V** are separated.

### 2.1.2 Safety Digital Input

The Safety Digital Input is explicitly intended for implementing a safety function. This means that the standard digital inputs must not be used to implement a safety function.

With the Safety Digital Input, safe triggering is carried out using the micro-controller. It interrupts the control signals to the driver or provides a pulse pattern which shuts down the connected motor in a controlled manner.

The Safety Digital Input can be parameterised with the following functions:

- **Voltage disable**

The micro-controller interrupts the control signals to the driver. No control pulses are provided to the semiconductor switches (T1 to T6) of the inverter. I.e. the current in the semiconductor switches and in the motor is interrupted and the motor runs down to a standstill.

- **Quick Stop**

The micro-controller shuts down the motor with control pulses according to a pre-set quick stop time.

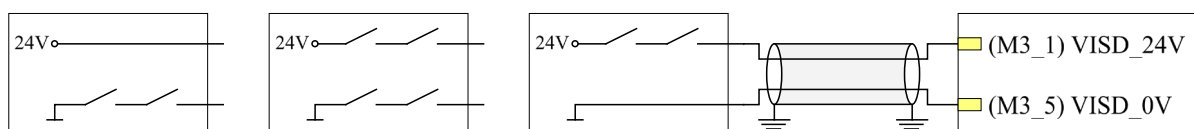

The Safety Digital Input has a separate reference potential **VISD\_0V**. I.e. in this case this reference potential can be disconnected to trigger the Safety Digital Input. Preferably, the **VISD\_24V** contact is disconnected.

## 2.2 Safety functions

### **WARNING**

#### **Mechanical brake failure**

Control of a mechanical brake by means of the frequency inverter is not fail-safe. Triggering of the STO and the fault response function causes the application of a mechanical brake which is controlled by the frequency inverter. The brake takes the entire load of the drive units and all of its rotating masses and attempts to stop it.

A brake which is not designed to take the full load (e.g. a holding brake) may be damaged and may fail. This can cause severe or fatal injuries or damage to the equipment, e.g. due to falling loads.

- Design the brake as an operating brake
- Ensure that the drive unit is stopped before the STO function is activated.

### 2.2.1 Safe Torque Off, STO

The STO function prevents the supply of motive power to the motor. According to ISO 1411, this function can be used to prevent unexpected starting and/or switch off the driving torque as quickly as possible (see technical data → response time) and allow the drive run down to a standstill (motor with work machine).

This behaviour corresponds to stop category 0 (uncontrolled stopping) according to EN 60204-1. Depending on the application the movement while running down to a standstill can cause a hazard for an undefined time. Detection of whether or when the drive unit has achieved a safe state is not integrated into the frequency inverter.

Depending on the switching equipment and use of a safe shut-down method, an STO function with safety category 4 as per DIN EN ISO 13849-1 can be implemented.

Bei einer Synchronmaschine kann es beim Versagen des Leistungsteils des Frequenzumrichters trotz aktivierter STO-Funktion zu einer Ausrichtbewegung um eine Polteilung kommen.

### 2.2.2 Safe Stop 1 time-controlled, SS1-t

The SK 3x1P series frequency inverter supports the implementation of the SS1 function in the SS1-t (Safe Stop 1 time-controlled) version.

To stop the motor, the frequency inverter triggers a quick stop. After an application-specific time, the STO function is switched on. This behaviour corresponds to stop category 1 (controlled stopping) according to IEC 60204-1. The changeover to the STO function is time-controlled via an external, fail-safe time relay (delayed output of an external safety device).

### **Information**

#### **Controlled stopping**

Controlled stopping is triggered via the Safety Digital Input and meets lower safety requirements than the STO function, which is triggered via the Safe Pulse Block.

Controlled stopping with SS1-t can fail without detection and must not be used if this failure can cause a hazardous situation in the application.

### 2.2.3 Priorities and response to faults

As the Safe Pulse Block is based on switching off the supply voltage to the drivers of the inverter's semiconductor switches (T1 to T6), this shut-down method has the highest priority. I.e. if the safety function STO is implemented with the Safe Pulse Block, the safety function STO also has the highest priority. If the safety functions STO and SS1-t are implemented in parallel, it must be noted that controlled stopping of the motor via the Safety Digital Input is interrupted by triggering the Safe Pulse Block.

The Safety Digital Input has an internal fault diagnosis. If this diagnosis detects a fault, the control signals to the drivers of the semiconductor switches (T1 to T6) of the inverter are switched off. This fault response corresponds to the behaviour of the safety function STO with the special feature that this fault state can only be acknowledged by resetting the mains voltage of the frequency inverter. Acknowledgement via a bus system or the digital inputs is not possible.

NOTE: The SS1-t function must not be used if a hazardous situation can result in the application due to the fault response.

## 2.3 Examples / Implementation

The following shows some examples of solutions for the safety functions STO and SS1-t.

### 2.3.1 STO function

Implementation of a safety function usually requires the use of a protective switching device. The category of the function is determined by the component with the lowest category.

#### Safe Pulse Block

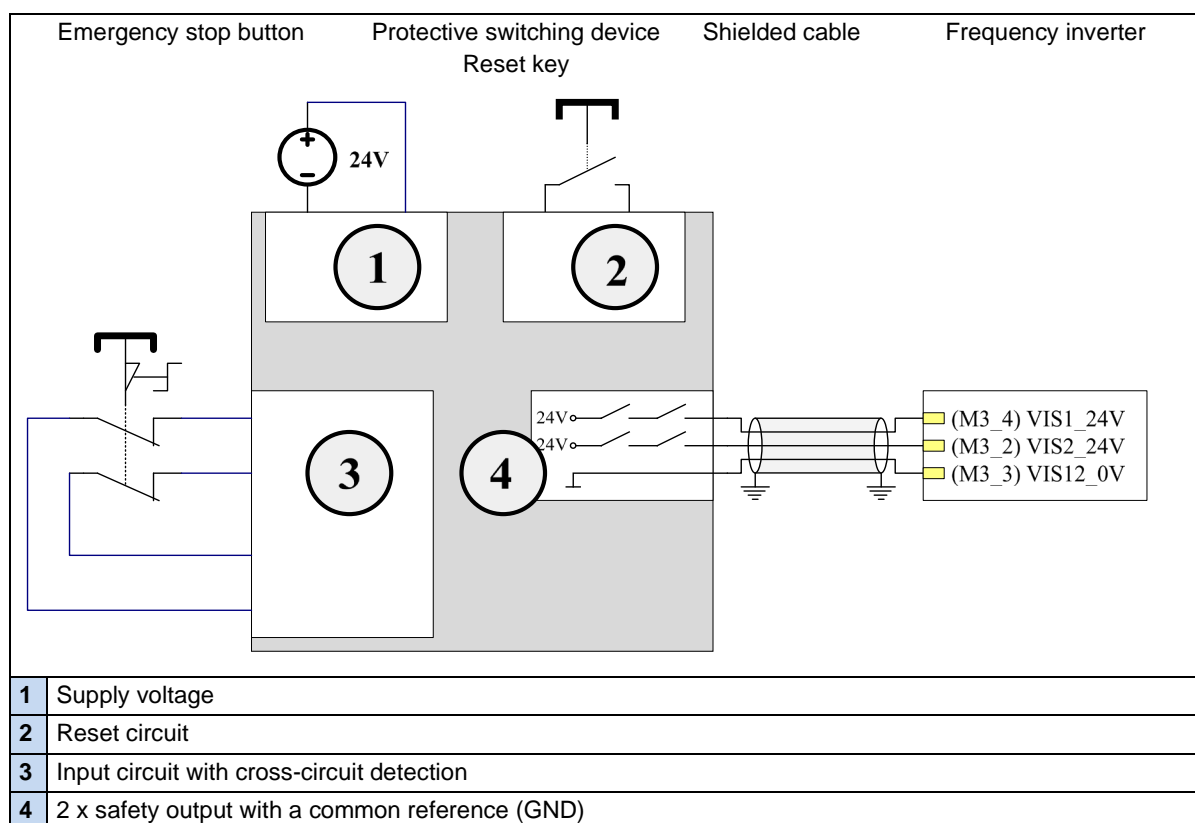

If the Safe Pulse Block is triggered for an enabled frequency inverter, this results in the error **E018** (18.0 "Safety circuit"). To prevent this, the Safety Digital Input can additionally be used with the Voltage Disable function (**P424 = 1**).

The typical response time can be reduced by additional use of the Safety Digital Input. A second safety output is required to control this.

This solution is preferable, especially in cases where the switching device only checks its safety outputs in the course of an enabling cycle, as is the case with some electro-mechanical switching devices. A suitable inspection interval must be specified according to the safety requirements.



### Safe Pulse Block with Safety Digital Input

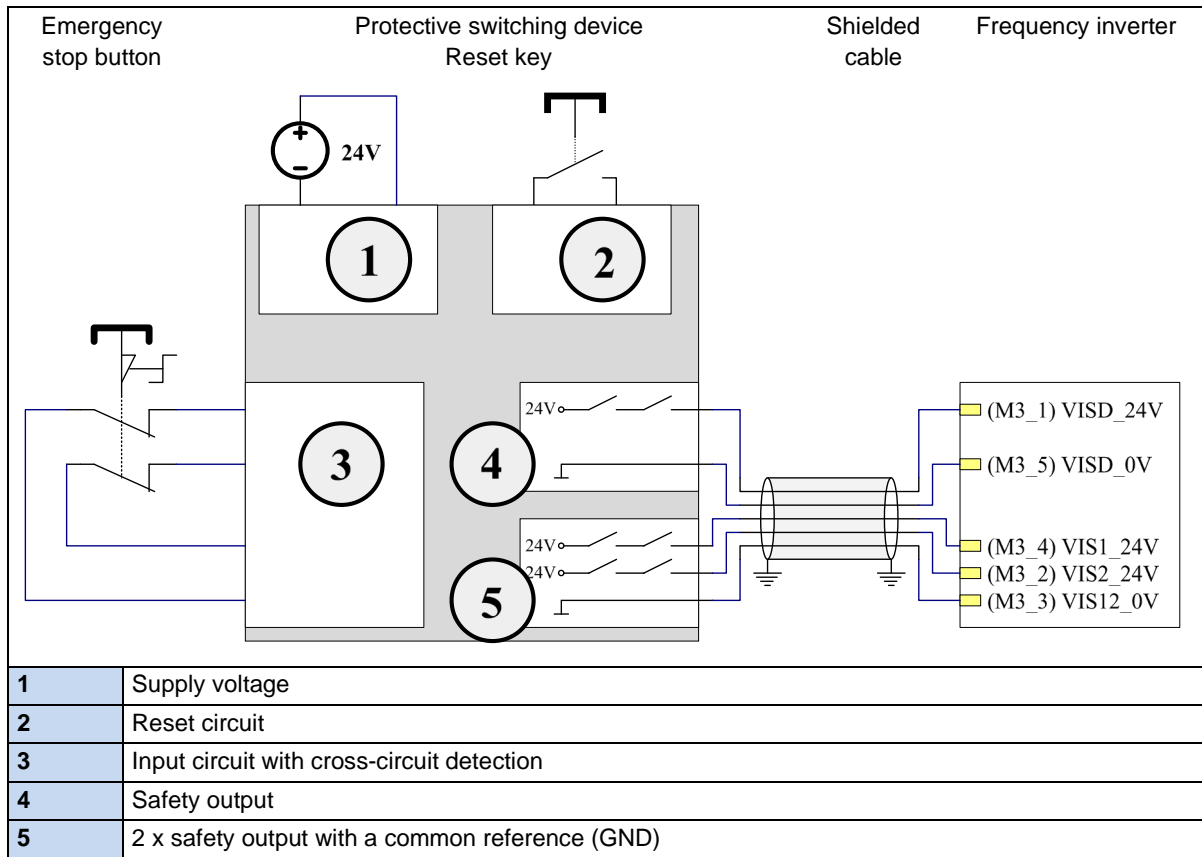

The Safe Pulse Block and the Safety Digital Input are connected via an M12 socket. A fault exclusion may need to be performed, [see 2.3.5 "Exclusion of wiring faults"](#).

The requirements for category 4 and PL e (Performance level e) are only fulfilled by the Safe Pulse Block. The Safety Digital Input only achieves category 2 and PL d (Performance Level d).

During the period between activation of the safety function via the Safety Digital Input and activation of the STO via the Safe Pulse Block, the frequency inverter can also only fulfil category 2 and PL d.

### 2.3.2 SS1-t function

The Safety Digital Input with the Quick Stop function (**P424 = 2**) is always required to implement the function SS1-t.

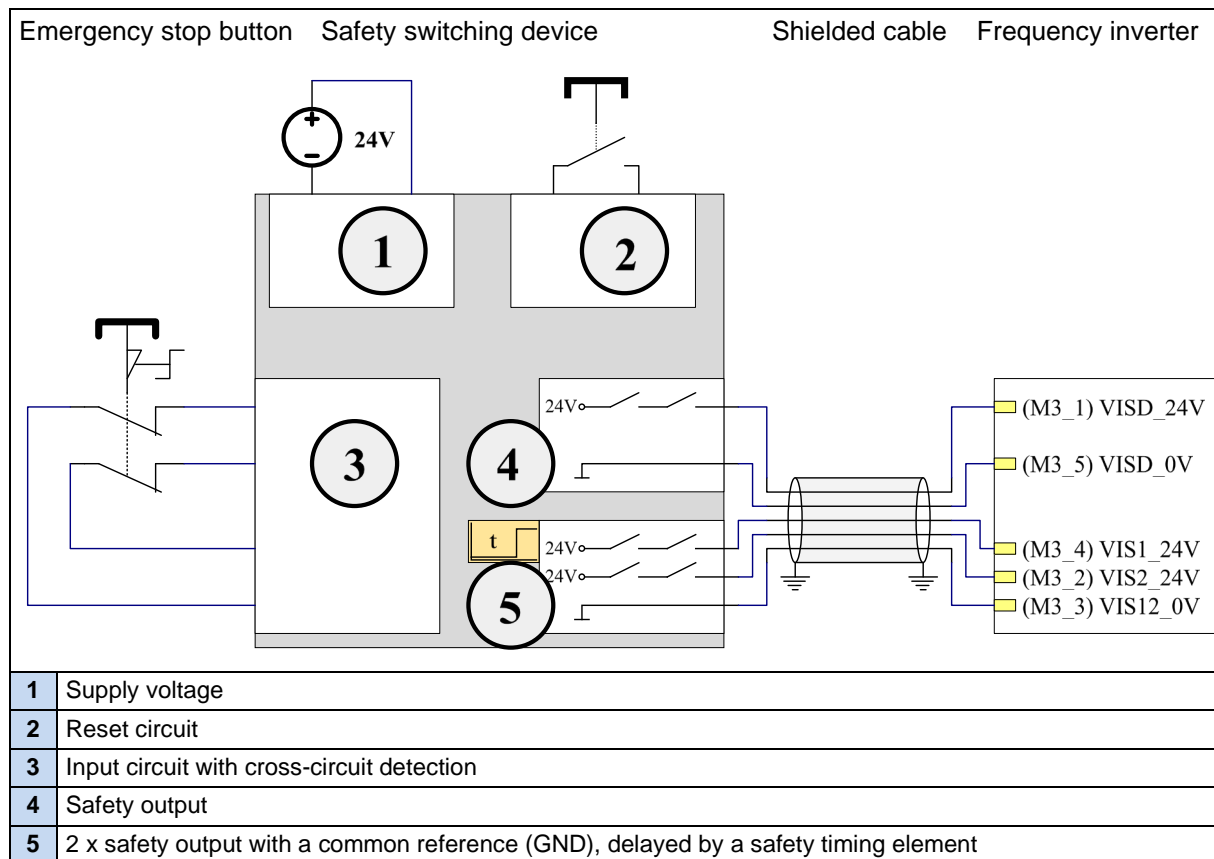

Actuation of the emergency stop button (call-up of the safety function) initially triggers a controlled stopping action via the Safety Digital Input. In this case, it must be ensured that the drive is brought to standstill within the parameterised “Quick stop time” (**P426**). After the elapse of a delay time which is controlled by the protective switching device, the STO function is triggered via the Safe Pulse Block. The delay time must be dimensioned so that the delay is longer than the quick stop time plus the “DC Run-on time” (**P559**). The delay time must be selected so as to be fail-safe.

After the delay time which is set in the protective switching device has elapsed, the frequency inverter always switches to the STO function. This also applies in the case of failure of the controlled stopping action.

SK 300P series frequency inverters are equipped with additional control which is set via the “Safety SS1 max. time” parameter (**P423**). If the motor is not stopped within the “Safety SS1 max time” (**P423**), the frequency inverter performs the fault response action and generates an error message. I.e. in this case the motor also runs down to a standstill.

The Safe Pulse Block and the Safety Digital Input are connected via an M12 socket. A fault exclusion may need to be performed [2.3.5 "Exclusion of wiring faults"](#).

The requirements for category 4 and PL e are only fulfilled by the Safe Pulse Block. The Safety Digital Input only achieves category 2 and PL d (Performance Level d).

During the period between activation of the SS1-t safety function via the Safety Digital Input and activation of the STO function via the Safe Pulse Block, the frequency inverter can also only fulfil the requirements of category 2 and PL d.

### 2.3.3 Simple re-start block

Category 4 as per DIN EN ISO 13849-1 can be achieved with direct dual-channel triggering of the Safe Pulse Block using a safe switching element. The following illustrations show typical examples with an emergency stop button (positively driven contacts, category 4).

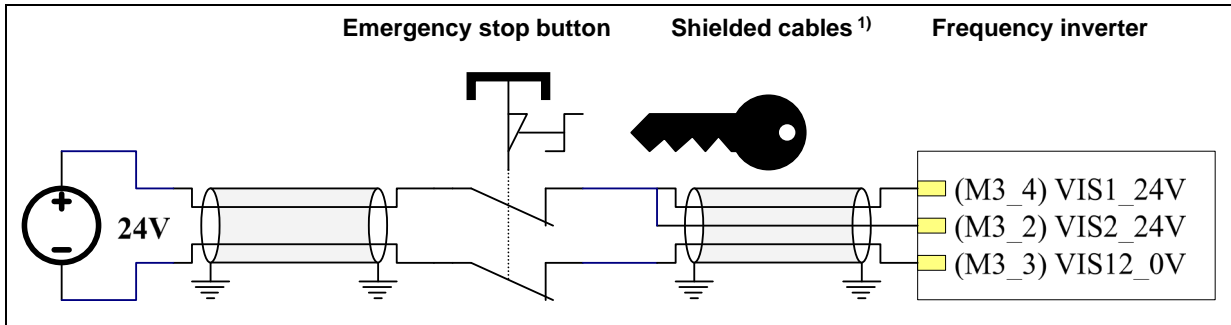

1) Shielded cables to exclude faults as per DIN EN ISO 13849-2

or

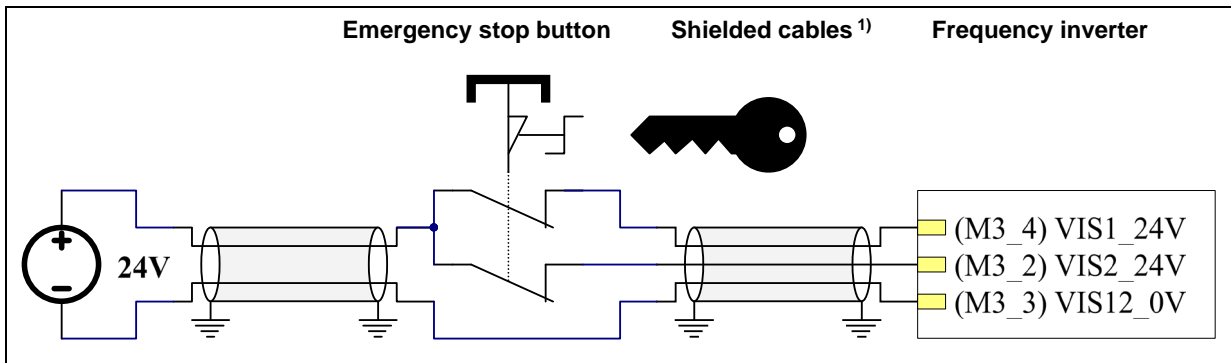

1) Shielded cables to exclude faults as per DIN EN ISO 13849-2

To achieve safety category 4, fault exclusion as per DIN EN ISO 13849-2 Section D.5 must be possible for the upstream components (hard-wiring and dual-channel button with independent, positive-opening contacts). I.e., in this example, the emergency-stop button and the wiring must be designed so that short-circuiting at the emergency-stop button and short-circuits to other live systems can be ruled out.

In this example, there is no reset circuit as is the case with the protective switching devices. If the result of risk analysis shows that cancellation of the stop command must be acknowledged by a deliberate manual action, the resetting requirements can be fulfilled organisationally (e.g. by an emergency-stop button with key release and storage of the key away from the machine).

If the Safe Pulse Block is triggered for an enabled frequency inverter, this results in the error **E018** (18.0 "Safety circuit").

#### Information

With the Automatic Fault Acknowledgement (**P506**) and Automatic Starting (**P428**) functions (see BU 0800), the drive starts immediately after the emergency stop button is released. For this reason, it is urgently recommended that these functions are not used in combination and especially not for safety-relevant applications.

### 2.3.4 Example without Safe Pulse Block

#### **WARNING**

##### Hazardous movement

If the safety functions STO/SS1-t are exclusively implemented via the Safety Digital Input, the drive can be unexpectedly supplied with power at any time, even after it has been stopped. Under some circumstances this may cause hazardous movement. In this case, the fault response action is performed at the latest after the maximum fault response time (see technical data → 35 ms).

- Implement the safety function with the Safe Pulse Block.

It is possible to implement the safety function STO or SS1 with the Safety Digital Input and a protective switching device only. However, according to DIN EN ISO 13849-1, with this switching variant, the maximum safety category that can be achieved is category 2. However, the condition for this is that in addition to the Safety Digital Input, all other components (protective switching device, emergency stop button, wiring) also fulfil the requirements for category 2.

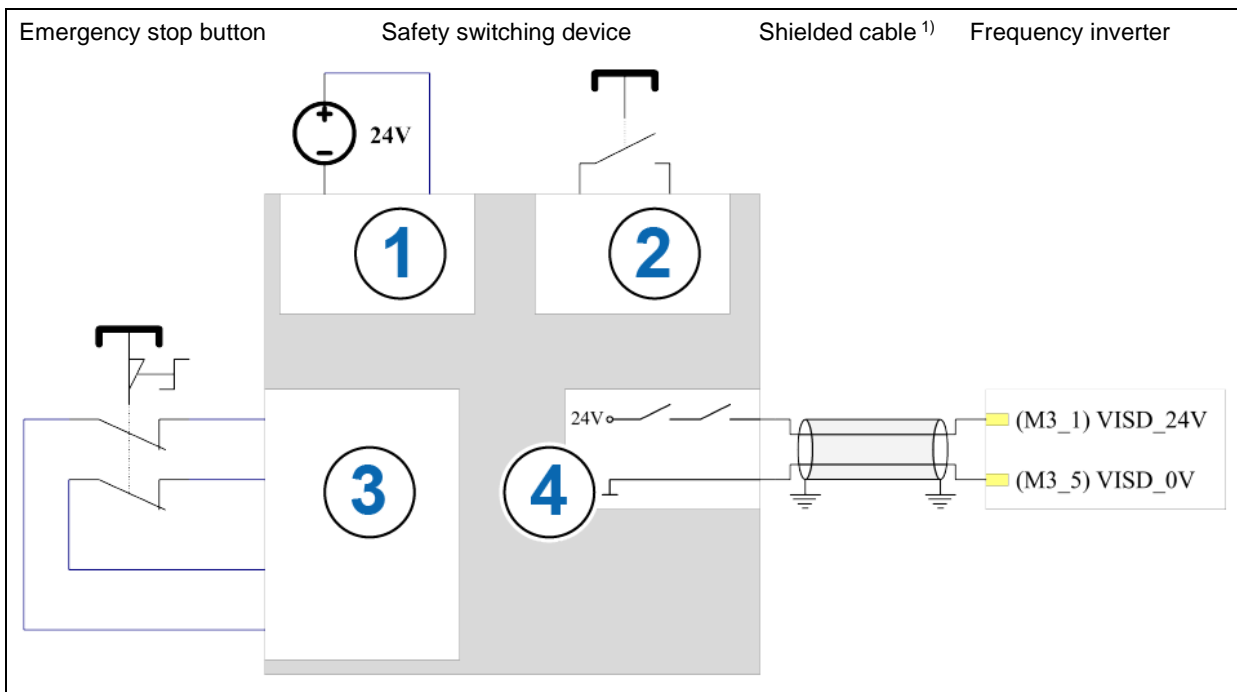

1) Shielded cable to exclude faults as per DIN EN ISO 13849-2

1	Supply voltage
2	Reset circuit
3	Input circuit with cross-circuit detection
4	Safety output

To implement the STO safety function, the Safety Digital Input is parameterised to the Voltage Disable function (**P424 = 1**).

The Safety Digital Input with the Quick Stop function (**P424 = 2**) is parameterised for implementation of the SS1-t function. The quick stop time is set via parameter **P426**. It must be ensured that the drive is actually brought to standstill within the parameterised quick stop time.

### Information

#### Category

Implementation of safety switching with only the Safety Digital Input as described above only enables compliance with safety category 2 or Performance Level d as a maximum,  8.1 "Safe Pulse Block and Safety Digital Input".

This switching version should therefore only be considered if only low requirements for functional safety need to be fulfilled and if the risk assessment has shown that failure of the safety function can only result in slight (usually temporary) injuries. In case of doubt, the Safe Pulse Block should always be used,  2.1.1 "Safe Pulse Block".

#### 2.3.5 Exclusion of wiring faults

An exclusion of faults may be necessary in order to fulfil the requirements of safety category 4 as per DIN EN ISO 13849-1. Neither a single detected fault nor an accumulation of undetected faults may result in the loss of the safety function.

A short-circuit between any particular conductors, e.g. from a 24V control cable to the 24V input of a safe shut-down method or between Safe Pulse Block and Safety Digital Input, can be prevented by means of suitable measures that justify the assumption of fault exclusion according to DIN EN ISO 13849-2. Separate cable duct, installation in armoured conduit, shielded cables etc. are possible.

It must be noted that there is only one M12 socket on the device for Safe Pulse Block and Safety Digital Input and that these are therefore routed in a sheathed cable.

Further possibilities in order to fulfil category 4 as per DIN EN ISO 13849-1 include monitoring of the switching device's safety outputs via cross-circuit detection or switching off the 24V and GND outputs. Restrictions  2.1 "Design of the safe shut-down method".

More precise details result from the risk assessment and the FMEA for the specific application.

If no shielded cable is used for wiring the safety function, possible effects of electromagnetic fields must be taken into account. Hence, the use of a 1 m long cable (in a separate cable duct) in an environment without strong electromagnetic fields is relatively safe, whereas the installation of a long cable in the direct vicinity of a powerful transmitter or a medium voltage distributor may cause failure of the safety function. Because of this, use of shielded cables is generally recommended.

## 3 Assembly and installation

The installation instructions contained in this manual only deal with issues that are related to functional safety. For further information, please refer to the manual for the relevant frequency inverter (BU 0800).

### 3.1 Installation and assembly

The frequency inverter must comply with protection class IP55 or IP66 as a painted version.

### 3.2 Electrical connection

The information for installation or electrical connection from the manual BU 0800 as well as all of the following information must be observed.

#### WARNING

##### **Electric shock**

Contact with electrically live components may result in electric shock, possibly with serious or fatal injuries.

- Disconnect the device electrically before starting installation work.
- Only work on devices with switched-off power.

#### WARNING

##### **Electric shock**

The frequency inverter has a hazardous voltage for up to 5 minutes after it has been switched off

- Only begin work after a waiting time of at least 5 minutes since the mains was switched off (disconnection).

#### 3.2.1 Mains connection

Devices for implementation of a safety function must only be operated on TN or TT networks. Grounded Corner operation is not intended.

For operation in IT networks, the device needs to be configured by adaptation of the integrated line filter. Modification of the mains filter is performed at the factory and must be taken into account in the order. Configuration for IT networks reduces the EMC.

#### **NOTICE**

##### **Operation in IT networks - mains fault**

If a mains fault (short-circuit to earth) occurs in an IT network, the link circuit of a connected frequency inverter may become charged, even if it is switched off. This results in destruction of the link circuit capacitors due to overcharging.

- Connect a braking resistor to dissipate excess energy.

In standby, the error message "Overvoltage Ud" may occur despite connection of the braking resistor. This indicates an earth fault. The use of the braking resistor to dissipate the charging prevents the device from being destroyed or damaged.

#### NOTICE!

##### Operation in IT networks

If a fault is detected in the safety circuit of the Safety Digital Input, pulse generation by the frequency inverter is switched off. This also affects control of the brake chopper. If the Safety Digital Input is used (**P424 = 1** or **P424 = 2**), possible triggering faults are:

- Detected fault in the Safety Digital Input hardware
- "Safety SS1 max. time" (**P423**) exceeded
- Incorrect input of the "Safety CRC" (**P499**) checksum or the password (**P497**, **P498**).

If such a fault occurs, and at the same time there is an earth fault in the IT network, the frequency inverter cannot be protected against possible overcharging of the link circuit capacitors. The frequency of hardware faults is very low, so that special care is necessary during commissioning in the IT network.

It is recommended that parameterisation and earth fault tests, e.g. testing of an earth fault monitor, are not carried out simultaneously.

#### 3.2.2 Control cable connections

The M12 socket **M3** of the SK 3x1P devices is located on the upper side of the housing.

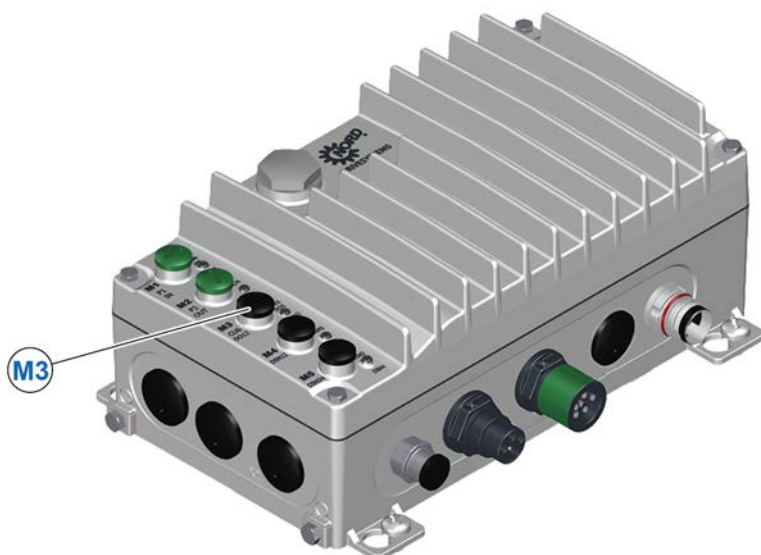

<b>M3</b>	M12 socket M3
-----------	---------------

#### Information

Install control cables separately from mains and motor cables and shield them as necessary.

Information on the socket assignment can be found in the instruction manual  [BU 0800](#).

### 3.2.3 Details on control terminals

The STO function is implemented with dual channels. For a single channel version the inputs VIS1\_24V and VIS2\_24V must be connected in parallel.

For the SS1-t function, the Quick Stop function must be triggered via the Safety Digital Input. For this, only the Safety Digital Input VISD\_24V with connection number 1 is to be used against the reference potential on connection number 5. The function is set via the Safety Digital Input parameter (**P424**).

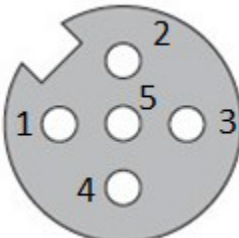
Connection of M12 socket (A-coded)	No.	Designation	Description
	1	VISD_24V	Safety Digital Input for SS1-t (with SIL capability)
	2	VIS2_24V	STO Input 2
	3	VIS12_0V	Reference Potential STO Inputs
	4	VIS1_24V	STO Input 1
	5	VISD_0V	Reference Potential Safety Digital Input

## 3.3 Details of the safe shut-down method

### 3.3.1 Wiring and shielding

A shielded cable is recommended for use of Safe Pulse Block and the Safety Digital Input,  2.3.5 "Exclusion of wiring faults". The shield must be connected on both sides. The voltage drop in the cable must be taken into consideration.

### 3.3.2 Operation with OSSD

OSSD outputs (Output Signal Switching Device) are outputs which perform a self-test with the aid of test pulses. Depending on the state of the output, these are switched on or off cyclically during a short time window. The voltage level from the output is read back and checked as to whether the output follows the expected change of voltage level. The inputs must not interpret the test pulses as changes of state.

The Safe Pulse Block and the Safety Digital Input are specially designed for use with an OSSD. The cable resistance and capacitance of the cable used must be taken into consideration.



#### 3.3.2.1 Individual operation

Different maximum cable resistances for the Safe Pulse Block result from the rated voltage, power and pulse frequency of the frequency inverter. The various cases are categorised into application classes:

Frequency inverter			Pulse frequency	Application class
Size	Power	Types		
Size II & Size III	370 W ... 1.5 kW	SK 3x1P-370-340	6 kHz	A
		SK 3x1P-750-340	16 kHz	B
SK 3x1P-950-340				
SK 3x1P-111-340				
Size III	2.2 kW ... 3.0 kW	SK 3x1P-151-340	6 kHz	A
		SK 3x1P-221-340	16 kHz	C
		SK 3x1P-301-340		

The following maximum cable resistances are permissible depending on the application class:

Application class	A	B	C
$R_{wire,max}$	11.0 $\Omega$	8.5 $\Omega$	7.5 $\Omega$

The internal resistance of the source and the resistance of the switch in an upstream OSSD must be taken into consideration. The same values apply for the return conductor, whereby this must only carry the currents of the Safe Pulse Block. The following applies:

$$R_{wire} = \rho_{cu} \cdot \frac{l}{q} \text{ with } \rho_{cu} \cong 19 \Omega \cdot \frac{mm^2}{km} \text{ for } \vartheta_{cu} = 40^\circ C$$

$l$ = Cable length [km]
$\rho_{cu}$ = Specific resistance of copper [ $\Omega \cdot mm^2/km$ ]

$q$ = Cable cross-section [mm]
$\vartheta_{cu}$ = Cable temperature [ $^\circ C$ ]

For cable temperatures above 40°C, the specific resistance  $\rho_{cu}$  must be corrected according to the temperature coefficient  $\alpha_{cu} = 4 \cdot 10^{-3} 1/K$  (increase by 0.4% per K).

The minimum input voltage of the protective switching device  $V_{24V, min}$  for operation of the Safe Pulse Block on an OSSD is 19.2 V. This value increases as follows depending on the maximum permissible cable resistance:

$$V_{24V,min} = 19.2 V + 2.4 V \cdot \frac{R_{wire}}{R_{wire,max}}$$

#### Information

Multiple device operation reduces the maximum cable resistance depending on the number of frequency inverters and the position of the frequency inverter.

The capacitance between the wires (including the shield capacitances) must not exceed a value of **C = 15 nF** for each frequency inverter which is connected.

The value **C** is determined as follows:

$$C = 3 \text{ nF} * t_{\text{OSSD}} / 0.1 \text{ ms} \quad \text{where } t_{\text{OSSD}} = \text{Width of the test pulse, max. } 0.5 \text{ ms}$$

Additional restrictions may apply with regard to the protective switching device.

---

 **Information**

---

The minimum permissible OSSD pulse for the Safety Digital Input and Safe Pulse Block is 200  $\mu\text{s}$ .

---

If the Safe Pulse Block of the module is used with a single channel, i.e. the two inputs VIS1\_24V and VIS2\_24V are connected in parallel, the minimum input voltage  $V_{24V,\text{min}}$  is increased by a further 0.4 V.

No corrections are necessary if the Safety Digital Input is connected in parallel with the Safe Pulse Block.

#### 3.3.2.2 Multiple device operation

If several frequency inverters are operated with one protective switching device, the switching capacity of the switching device and the load rating of the 24 V mains unit must be observed.

The shield must be correctly connected.

The voltage drop in the cable and the cable resistances must be taken into consideration.

The permissible cable resistance is reduced if the Safe Pulse Block of several frequency inverters is operated with an OSSD. For the minimum input voltage at the protective switching device, the calculation must be adjusted depending on the number of frequency inverters.

#### All frequency inverters at the end of the cable:

$$R_{wire,max}(N_{FI}) = \frac{R_{wire,max}}{N_{FI}} \text{ with } N_{FI} = \text{"Number of frequency inverters"}$$

$$V_{24V,min} = 19.2 V + 2.4 V * \frac{R_{wire}}{R_{wire,max}} * N_{FI}$$



#### Information

For  $R_{wire,max}$ , refer to table 3.3.2 "Operation with OSSD".

#### Frequency inverters distributed evenly along the length of the cable:

$$R_{wire,max}(N_{FI}) = R_{wire,max} * \frac{2}{N_{FI} + 1} \text{ with } N_{FI} = \text{"Number of frequency inverters"}$$

$$V_{24V,min} = 19.2 V + 2.4 V * \frac{R_{wire}}{R_{wire,max}} * \frac{N_{FI} + 1}{2}$$

If the internal resistances of the source and the OSSD dominate, the equations for the case of all frequency inverters at the end of the cable must be used.

If different frequency inverters are operated on an OSSD, the lowest value for  $R_{wire,max}$  must be used.

#### Example

Given:

- Four 400 V SK 301P frequency inverters are connected to an electronic protective switching device. These are two times the power 750 W with a pulse frequency of 6 kHz and two times the power 950 W with a pulse frequency of 16 kHz.
- The frequency inverters are evenly distributed along the length of the cable.
- A five-wire, shielded cable with a total length of 50 m is used. Each wire has a cross section of 0.34 mm<sup>2</sup>. One wire each is used for both channels of the CU6-STO.

The smaller value is used for the maximum permissible cable resistance (in this case for 950 W, 16 kHz / application class B).

$$R_{wire,max} = 8.5 \Omega$$

$$R_{wire} = \rho_{CU...} * \frac{l}{q} = 19 \Omega * \frac{mm^2}{km} * \frac{0.05 km}{0.34 mm^2} = 2.79 \Omega$$

The following formula applies for inverters which are evenly distributed along the length of the cable.

$$R_{wire,max}(N_{FI}) = R_{wire,max} * \frac{2}{N_{FI} + 1}$$

$$R_{wire,max}(N_{FI}) = 8.5 \Omega * \frac{2}{4 + 1} = 3.4 \Omega > 2.79 \Omega = R_{wire} \Rightarrow \text{OK!}$$

$$V_{24V,min} = 19.2 V + 2.4 V * \frac{R_{wire}}{R_{wire,max}} * \frac{N_{FI} + 1}{2} = 19.2 V + 2.4 V * \frac{2.79 \Omega}{8.5 \Omega} * \frac{4 + 1}{2} = 21.2 V$$

Result: The cable resistance is low enough and the supply voltage must be at least 21.2 V.

Tip: If the calculated resistance is too high, the OSSD can be located in the middle of the cable between the inverters. A star configuration with the OSSD at the centre of the star is also possible. In this case, the cable capacity may be the limiting factor. In case of doubt, a larger cable cross-section must be used.

### 3.3.3 EMC

The EMC guideline values (see BU 0800) can be complied with by using an EMC-compliant wiring up to a cable length of 100 m between the protective switching device and the frequency inverter.

## 4 Commissioning

Only specific issues for **functional safety** during commissioning are considered in the following. All information relating to the device and its commissioning can be found in the operating manual for the frequency inverter BU 0800.

The Safe Pulse Block is required for implementation of the safety function STO or SS1-t. The Safety Digital Input is additionally required for the safety function SS1-t. This may also be used for implementation of the STO safety function. For this, the Safety Digital Input must be configured with a special function. All parameterisation tools can be used for parameterisation, e.g. the NORDAC ACCESS BT Bluetooth stick or an Ethernet bus. Calculation of the CRC checksum can only be carried out with the NORDCON PC software. For all other methods, after parameterisation of the safety parameters the correct CRC checksum must be entered manually [📖 5.1 "Parameterisation"](#). Typical CRC checksums can be obtained from the parameter description for **P499** "Safety CRC" in this manual.

### 4.1 Commissioning steps for STO

Two safety outputs of the protective switching device are connected with the two inputs of the Safe Pulse Block [📖 2.1.1 "Safe Pulse Block"](#).

Depending on the required category, a wiring fault (short-circuit between any particular conductors) must be able to be excluded. It is recommended that a shielded cable is used for the Safe Pulse Block and that the shield is correctly connected, [📖 2.3.5 "Exclusion of wiring faults"](#). If a protective switching device with OSSDs that is able to detect short circuits between the OSSDs and external voltages is used, it may be possible to dispense with the use of a shielded cable.

- The response time can be reduced by the additional use of the Safety Digital Input. For this, the Safety Digital Input is parameterised with the Voltage Disable function (**P424 = 1**). The different reference potentials must be considered, [📖 2.1 "Design of the safe shut-down method"](#).

It must be noted that the Safety Digital Input has a lower safety category than the Safe Pulse Block and therefore the STO function may reduce to the longer response time of the Safe Pulse Block.

#### 2.3.5 "Exclusion of wiring faults"

- If the assessment of the functional safety of the end application shows that monitored starting is necessary, "Automatic starting" (**P428**) must not be used (setting "0" Off). This prevents the drive from re-starting automatically if the requirement for the Safe Pulse Block is removed.

### 4.2 SS1-t commissioning steps

A safety output of the protective switching device is connected to the Safety Digital Input, [📖 2.1 "Design of the safe shut-down method"](#).

It is recommended that a shielded cable is used and that the shield is correctly connected, [📖 2.3.5 "Exclusion of wiring faults"](#). Two time-delayed safety outputs of the protective switching device are connected with the two inputs of the Safe Pulse Block. Safety Digital Input must be parameterised with the Quick Stop function (**P424 = 2**).

## ⚠ WARNING

### Danger of injury due to failure of SS1-t

The stopping characteristics of the drive can be influenced by various factors. Therefore, the “Safe Stop 1” mode may possibly not be correctly complied with.

- The safety subfunction SS1-t must not be used in end applications in which failure of the SS1-t may result in a hazardous situation.
- In order to prevent malfunction, a final validation in the course of commissioning must demonstrate that the particular settings fulfil the requirements for the special intended use, and that the device will at no time be operated outside of its rated data.

For the SS1-t function, the “Safety SS1 max. time” monitoring time (**P423**) must be parameterised according to the requirements of the application. The delay time of the delayed safety outputs of the protective switching device must be rated so that it is longer than the set monitoring time.

The actual stopping time for the drive depends on various factors. It may deviate from the parameterised “Quick stop time” (**P426**) if, for example, one or more of the following events occur during the active quick stop.

- Achievement/exceeding of the power limits of the FI
- Achievement/exceeding of one or more parameterised limit values (e.g. **P112**, **P536**, **P537**)
- In unfavourable cases, the drive cannot be stopped to a standstill during the parameterised monitoring time. In this case an error is triggered and the inverter performs the fault response function and runs down to a standstill.
- The following sequence results if the SS1-t function is correctly implemented:  
 The ramp for controlled stopping results from the actual frequency, the “Quick stop time” (**P426**) and the “Maximum frequency” (**P105**), as well as the “Absolute mini. freq.” (**P505**). At the time  $t = 0$ , the Quick Stop is triggered via the Safety Digital Input. From the “Maximum frequency” (**P105**) the frequency inverter would require the entire “Quick stop time” (**P426**) to reduce the output frequency to 0 Hz. However, the braking ramp is only carried out down to the “Absolute mini. freq.” (**P505**). If an electro-mechanical brake is used, the output frequency remains at the “Absolute mini. freq.” (**P505**) for the set “Brake reaction time” (**P107**). After this, the brake is applied. Without an electro-mechanical brake, the Brake Reaction Time (**P107**) is parameterised to zero seconds (default value). This is followed by the “DC Run-on time” (**P559**) if an asynchronous motor is used. During this run-on time, the asynchronous motor is supplied with DC current to bring the drive to a complete standstill. The prerequisite for stopping is the correct design of the entire drive, and that the power limits of the inverter or parameterised limits are not exceeded. To safeguard controlled stopping, monitoring is performed as to whether the inverter is still controlled after the elapse of the “Safety SS1 max. time” (**P423**). This time must be selected to be greater than, but as little greater as possible than the value which results from the following equation:

$$D_{d,STO} > P423 > P426 * \frac{P105 - P505}{P105} + P107 + P559$$

Switching to the STO safety function is carried out at the time  $T_{d,STO}$  via the Safe Pulse Block input.

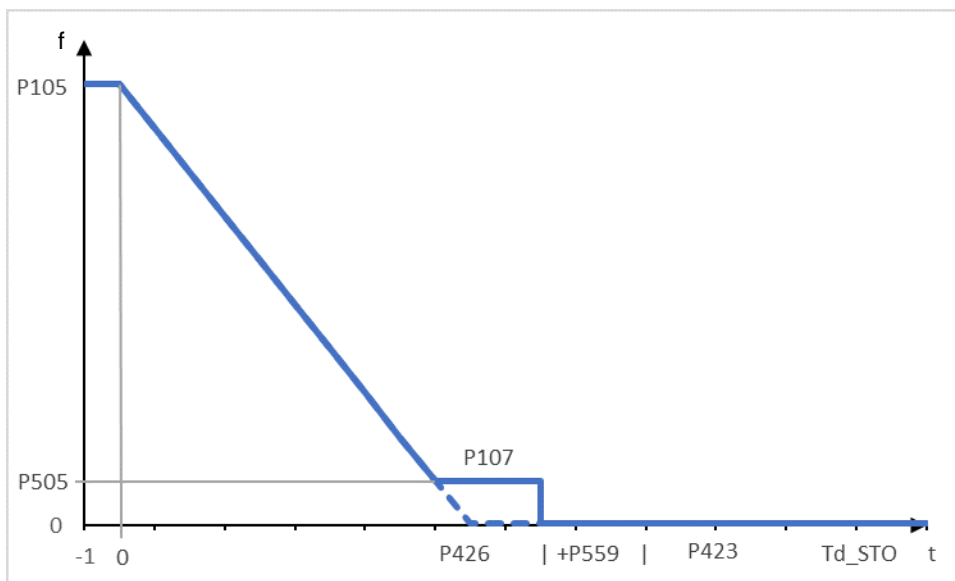

- In the event of an incorrect sequence, the following error messages occur:  
 If the STO safety function is triggered via the Safe Pulse Block while the inverter is being controlled, the error message **E018** (18.0 "Safety circuit") is issued. If this occurs before the motor has been stopped, the stopping sequence is discontinued. The connected motor runs down to a standstill. This behaviour results from the fact that the Safe Pulse Block has the highest priority.

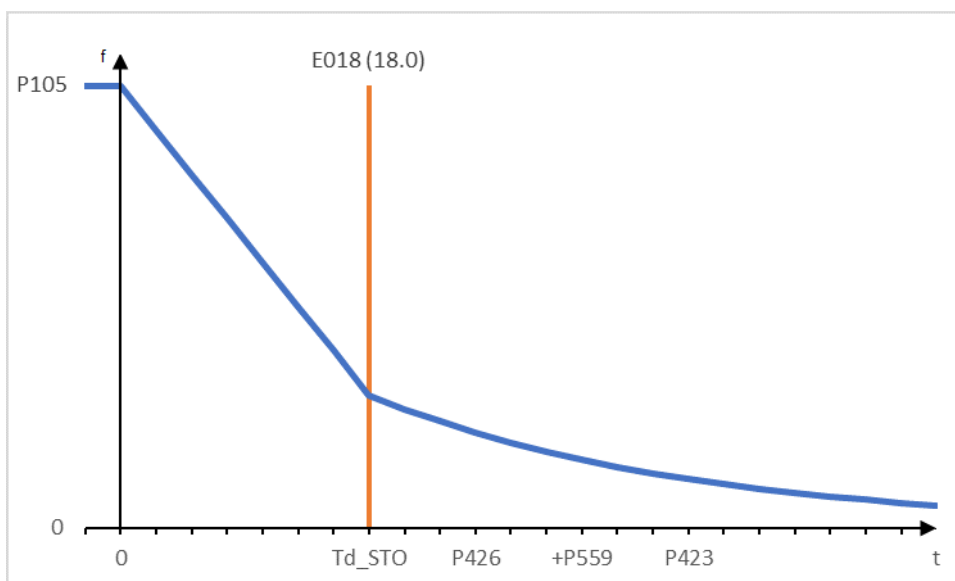

If the inverter is still being controlled after elapse of the “Safety SS1 max. time” (**P423**), the error message **E018** (18.5 “Safety SS1”) is issued. If this occurs before the motor has been stopped, the stopping sequence is discontinued. The connected motor runs down to a standstill.

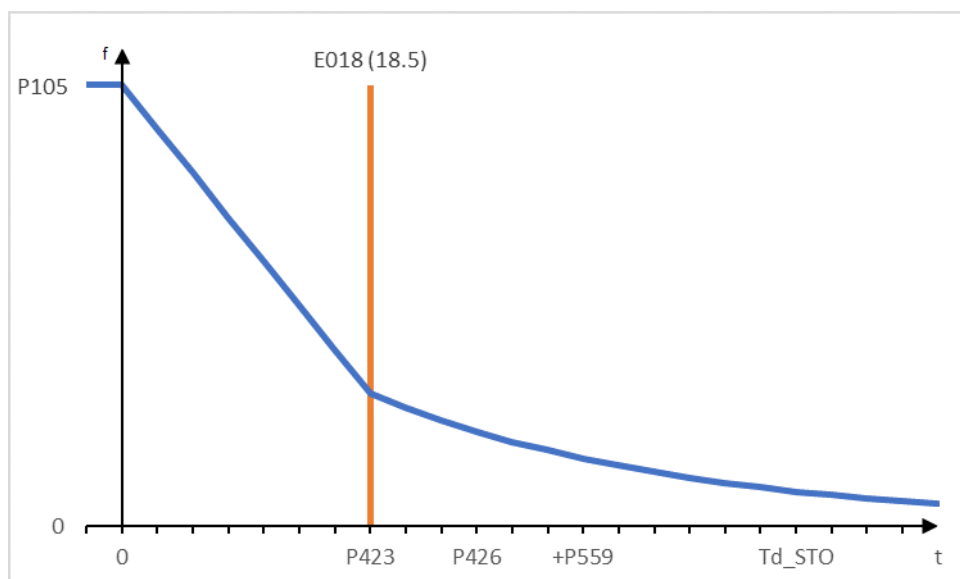

- If the assessment of the functional safety of the end application shows that monitored starting is necessary, “Automatic starting” (**P428**) must not be used (setting “0” Off). This prevents the drive from re-starting automatically if the requirement for the Safe Pulse Block is removed.

### 4.3 Validation

It is essential to demonstrate by validation that the requirements for intended special application are met.

For validation, IEC 61800-5-2:2016 stipulates at least the following points in the project documentation:

- Description of the application including an image
- Description of all safety-relevant components (including the software version) which are used in the application
- List of the safety subfunctions which are used
- Results of all tests of these safety subfunctions
- List of all safety-relevant parameters and their values in the frequency inverter
- Checksums, date of inspection and confirmation by the inspection personnel

The configuration tests for NORDAC *ON* in identical applications may be performed as a single type test for the identical application if it can be ensured that the safety subfunctions in all devices are configured as intended.

The safety subfunctions of NORDAC *ON* are maintenance-free. To rule out accidental re-parameterisation after validation, the safety parameters must be re-checked after each suspension of the safety password (**P497**). The validation, including documentation, must be repeated if the configuration is changed.



## 5 Parameters

The following only lists the specific parameters and display and setting options for the **Functional Safety** technology function. For a detailed overview of all available parameters, please refer to the frequency inverter manual BU 0800.

---

### Information

---

#### Loss of safe function

Loading of a parameter set can prevent the *Voltage Disable* and *Quick Stop* functions of the Safety Digital Input from correct functioning.

To ensure that unintended re-parameterisation has not occurred, the settings of “Safety SS1 max. time” (**P423**) and “Safe Dig.input” (**P424**) should be revalidated when password protection for the safety parameters is activated. This ensures that the safe functions operate correctly.

---

### 5.1 Parameterisation

The following applies for parameterisation of the Safety Digital Input:

For the Safety Digital Input there are two safety parameters, “Safety SS1 max. time” (**P423**) and “Safe Dig.input” (**P424**).

In order to edit the two parameters, the password protection must be cancelled if a password has been set (the password is disabled in the factory settings). Password protection is temporarily disabled with entry of the password in “Safety password” (**P497**). After this, both parameters can be changed as necessary.

In order for the two parameters to be adopted by the frequency inverter, the correct CRC checksum which is calculated via these two parameters must then be entered in “Safety CRC” (**P499**). The NORDCON PC software calculates the CRC checksum automatically when “Send” is pressed in “Safety CRC” (**P499**). For all other parameterisation options, the correct CRC checksum must be entered manually. For this, a table with frequently used value combinations is available in the parameter description for “Safety CRC” (**P499**). Alternatively, the CRC checksum can be calculated once with NORDCON and then used for the other parameterisation options.

The frequency inverter performs the fault response functions after it has adopted the changes to the safety parameters. If a password for the safety parameters has not yet been enabled, this must be activated by entering it in “Change safety passw.” (**P498**). Regardless of whether a safety password was already enabled, a restart of the frequency inverter must be performed. (24 V off → 60 s → 24 V on).

If a safety password has not been set, or if the CRC checksum does not match both safety parameters, the frequency inverter remains in the fault response function after the reset.

---

### Information

---

When parameterisation of the safety parameters is complete, the safety function must be revalidated.

The CRC checksum is also checked if no safety function is activated.

The password can be disabled again by temporarily disabling password protection with “Safety password” (**P497**) and then changing the password to 0 in “Change safety passw.” (**P498**).

If you forget the password, use the NORDCON software to reset. However, this also resets the safety parameters **P423**, **P424** and the CRC checksum **P499**!

---

### 5.2 Description of parameters

## 5.2.1 Explanation of parameter description

P000 (parameter number)	Operating para. disp. (parameter name)	xx <sup>1)</sup>	S	P
<b>Setting range</b> (or display range)	Representation of typical display format (e.g. (bin = binary) of possible setting range and number of decimal places	<b>Other applicable parameter(s):</b>	List of other directly related parameters	
<b>Arrays</b>	[-01] If parameters have a substructure in several arrays, this is shown here.			
<b>Factory setting</b>	{ 0 } Typical default setting of parameters in the as-delivered condition of the FI, or to which it is set after carrying out "Restore factory settings" (see parameter P523).			
<b>Scope of application</b>	List of variants for which this parameter applies. If the parameter is generally valid, i.e. for the entire model series, this line is omitted.			
<b>Description</b>	Description, function, meaning and similar for this parameter.			
<b>Note</b>	Additional notes about this parameter			
<b>Setting values</b> (or display values)	List of possible settings with description of their respective functions			

1) xx = Other codes



### Information

Unused lines of information are not listed.

### Notes / Explanations

Label	Designation	Meaning
<b>S</b>	Supervisor parameter	The parameter can only be displayed and changed if the relevant supervisor code has been set (see parameter <b>P003</b> ).
<b>P</b>	Depending on the parameter set	The parameter provides various setting options which depend on the selected parameter set.

### 5.2.2 Control terminals

<b>P423</b>	<b>Safety SS1 max. time</b>			
<b>Setting range</b>	0.01 ... 320.00 s			
<b>Factory setting</b>	{ 0.1 }			
<b>Description</b>	<p>“Safety SS1 max. time” is used to delay the output monitoring of the frequency inverter if the Safety Digital Input is parameterised to Quick Stop (<b>P424 = 2</b>). If the motor is still controlled after the set time, an error message is generated. The time to be set depends on the parameterised quick stop time, the brake reaction time and the flux delay. For asynchronous motors, the time to be set also depends on the DC run-on time.</p>			
<b>Scope of Application</b>	SK 3x1P with SK CU6-STO			
<b>Note</b>	<p>The set “Safety SS1 max. time” applies for all parameter sets. Be sure that the “Quick stop time” (<b>P426</b>) is matched for all parameter sets of the monitoring time.</p> <p>The parameter is only saved after entry and confirmation of the “Safety CRC” (<b>P499</b>). A parameter setting change is only applied after the external 24 V DC supply of the frequency inverter has been switched off and on again (24 V off → 60 s → 24 V on). Switching off the 400 V supply is not required for NORDAC ON or NORDAC ON+.</p> <p>If the safety functions are used, the parameters must be provided with password protection by use of “Change safety passw.” (<b>P498</b>).</p> <p>The “Safety SS1 max. time” (<b>P423</b>) is not changed by “Load factory setting” (<b>P523</b>). If the “Safety SS1 max. time” (<b>P423</b>) is to be changed to a default value, this must be carried out manually.</p>			

<b>P424</b>	<b>Safe Dig.input</b>		<b>S</b>	<b>P</b>
<b>Setting range</b>	0 ... 2			
<b>Factory setting</b>	{ 0 }			
<b>Description</b>	Assignment of a stop function for the Safety Digital Input of the frequency inverter.			
<b>Note</b>	<p>The parameter is only saved after entry and confirmation of the CRC checksum (<b>P499</b>). A parameter setting change is only applied after the external 24 V DC supply of the frequency inverter has been switched off and on again (24 V off → 60 s → 24 V on).</p> <p>Switching off the 400 V supply is not required for NORDAC ON or NORDAC ON+.</p> <p>If the safety functions are used, the parameters must be provided with password protection (<b>P498</b>).</p> <p>The parameter cannot be reset to the default value with “Load factory setting” (<b>P523</b>), but rather can only be reset manually.</p>			
<b>Setting values</b>	<b>Value</b>	<b>Meaning</b>		
	0	No function		
	1	Disable voltage The FI output voltage is switched off; the motor runs down freely.		
	2	Quick stop The FI reduces the frequency according to the programmed fast stop time from P426.		

P426	Quick stop time		P
<b>Setting range</b>	0... 320.00 sec		
<b>Factory setting</b>	{ 0.10 }		
<b>Description</b>	<p>Setting of the braking time for the quick stop function which can be triggered either via a digital input, the bus control, the keyboard or automatically in case of a fault.</p> <p>The quick stop time is the time which is taken for the linear frequency to decrease from the set "Maximum frequency" (<b>P105</b>) to 0 Hz. If an actual setpoint &lt; 100 % is used, the quick stop time is reduced correspondingly.</p>		
<b>Note</b>	<p>The quick stop time and the "SS1 max. time" (<b>P423</b>) must be matched to each other. The set quick stop times for all parameter sets must match the monitoring time.</p> <p><b>WARNING!</b> Danger of injury due to failure of SS1-t</p> <p>The stopping characteristics of the drive can be influenced by various factors. Therefore, the "Safe Stop 1" mode may possibly not be correctly complied with.</p> <ul style="list-style-type: none"> <li>• The safety subfunction SS1-t must not be used in end applications in which failure of the SS1-t may result in a hazardous situation.</li> <li>• In order to prevent malfunction, a final validation in the course of commissioning must demonstrate that the particular settings fulfil the requirements for the special intended use, and that the device will at no time be operated outside of its rated data.</li> </ul>		
P428	Automatic starting		S
<b>Setting range</b>	0 ... 1		
<b>Factory setting</b>	{ 0 }		
<b>Description</b>	<p><b>WARNING!</b> Danger of injury due to unexpected movements of the drive. Switch-on after an earth fault/short-circuit. Do <b>NOT</b> parameterise this parameter to "On" (<b>P428 = 1</b>), if "Automatic acknowledged." (<b>P506 = 6</b> "Always") has been parameterised! Secure drive against movements.</p> <p>This parameter defines how the FI responds to a static enabling signal when the mains voltage is applied (mains voltage On).</p> <p>In the standard setting <b>P428 = 0</b> Off, the FI requires a flank to enable (signal change from Low → High) at the relevant digital input.</p> <p><b>P428 = 1</b> "On" can be set if the FI must start immediately when the mains voltage is switched on. If the enable signal is permanently switched on, or equipped with a cable jumper, the FI starts up immediately.</p>		
<b>Note</b>	The setting "On" ( <b>P428 = 1</b> ) can only be enabled if the frequency inverter has been parameterised to local control ( <b>P509 = 0</b> or <b>P509 = 1</b> ).		
Setting values	Value	Meaning	
	0	Off	<p>The device expects a flank (signal change "low → high") at the digital input which has been parameterised to "Enable" in order to start the drive.</p> <p>If the device is switched on with an active enable signal (mains voltage on), it immediately switches to "Switch-on inhibit".</p>
	1	On	<p>The device expects a signal level ("high") at the digital input which has been parameterised to "Enable" in order to start the drive.</p> <p><b>NOTICE! Risk of injury! Drive starts up immediately!</b></p>

P434	Digital out function		P
Arrays	[-01] ... [-05]		
Description	Assignment of functions for the digital output		
Note	The digital outputs are not fail-safe.		
Setting values	Value	Meaning	
	0	Off	Output not used.
	01	External brake	For control of a mechanical brake on the motor. For details see BU 0800 <b>WARNING:</b> Brake failure! The control is not fail-safe! Design the brake as an operating brake. Ensure that the drive is brought to a standstill before "STO" becomes active.
	07	Fault	General error message. For details see BU 0800
	16	Quick stop active	A quick stop (P427) has been triggered.
	17	Quick stop+STO act.	STO, "Voltage disable" or "Quick stop" are active.
	39	STO inactive	This function depicts the reaction of the Safe Pulse Block. The signal drops (High → Low) when STO and Safe Stop are active.



P481	Func-BusIO Out Bits		S
Arrays	[-01] ... [-18]		
Description	Assignment of functions for Bus IO Out bits. The frequency inverter treats the Bus IO Out bits as digital outputs.		
Note	Setting the Bus IO Out bits is not fail-safe.		
Setting values	Value	Meaning	
	0	Off	Output not used.
	01	External brake	For control of a mechanical brake on the motor. For details see BU 0800 <b>WARNING:</b> Brake failure! The control is not fail-safe! Design the brake as an operating brake. Ensure that the drive is brought to a standstill before "STO" becomes active.
	07	Fault	General error message. For details see BU 0800
	16	Quick stop active	A quick stop (P427) has been triggered.
	17	Quick stop+STO act.	STO, "Voltage disable" or "Quick stop" are active.
	39	STO inactive	This function depicts the reaction of the Safe Pulse Block. The signal drops (High → Low) when STO and Safe Stop are active.

P497	Safety password	S
Setting range	- 32768 ... 32767	
Factory setting	{ 0 }	
Description	Entry of the password from <b>P498</b> , to unlock the parameters "Safety SS1 max. time" ( <b>P423</b> ), "Safe Dig.input" ( <b>P424</b> ) and "Safety CRC" ( <b>P499</b> ). At the same time, the password protection for "Change safety passw." ( <b>P498</b> ) is temporarily suspended.	
Note	The value which is entered here is lost when the control board of the frequency inverter is switched off. Password protection is active again.	

P498	Change safety passw.	S
Setting range	-32768 ... 32767	
Factory setting	{ 0 }	
Description	Specification of a password to prevent unauthorised changes to the setting values of "Safety SS1 max. time" ( <b>P423</b> ), "Safe Dig.input" ( <b>P424</b> ) and "Safety CRC" ( <b>P499</b> ). Password protection can be temporarily suspended with "Safety password" ( <b>P497</b> ).	
Note	The password is disabled with setting "0".	

P499	Safety CRC																																										
<b>Setting range</b>	0x0000.. 0xFFFF																																										
<b>Factory setting</b>	{ 0 }																																										
<b>Description</b>	<p>A CRC is necessary for saving the parameter which is relevant for the functional safety. NORDCON calculates the CRC automatically when this parameter is saved. If the CRC is input by any other method it must be calculated manually. After input of the CRC an error is triggered, in order to force a restart of the frequency inverter with adoption of the parameter. A false CRC results in an error when the frequency inverter is started. Typical values for manual input:</p> <table border="1" style="margin-left: auto; margin-right: auto;"> <thead> <tr> <th style="text-align: center;">Safety Digital Input (P424)</th> <th style="text-align: center;">Safety SS1 max. time (P423)</th> <th style="text-align: center;">Safety CRC (P499)</th> </tr> </thead> <tbody> <tr><td style="text-align: center;">No function</td><td style="text-align: center;">0.1</td><td style="text-align: center;">0xDACB</td></tr> <tr><td style="text-align: center;">Disable Voltage</td><td style="text-align: center;">0.1</td><td style="text-align: center;">0x971E</td></tr> <tr><td style="text-align: center;">Quick Stop</td><td style="text-align: center;">0.1</td><td style="text-align: center;">0x4161</td></tr> <tr><td style="text-align: center;">Quick Stop</td><td style="text-align: center;">0.2</td><td style="text-align: center;">0x6097</td></tr> <tr><td style="text-align: center;">Quick Stop</td><td style="text-align: center;">0.3</td><td style="text-align: center;">0xBA5C</td></tr> <tr><td style="text-align: center;">Quick Stop</td><td style="text-align: center;">0.5</td><td style="text-align: center;">0xF54D</td></tr> <tr><td style="text-align: center;">Quick Stop</td><td style="text-align: center;">0.7</td><td style="text-align: center;">0x247E</td></tr> <tr><td style="text-align: center;">Quick Stop</td><td style="text-align: center;">1</td><td style="text-align: center;">0x4664</td></tr> <tr><td style="text-align: center;">Quick Stop</td><td style="text-align: center;">2</td><td style="text-align: center;">0x6E9D</td></tr> <tr><td style="text-align: center;">Quick stop</td><td style="text-align: center;">3</td><td style="text-align: center;">0x3493</td></tr> <tr><td style="text-align: center;">Quick Stop</td><td style="text-align: center;">5</td><td style="text-align: center;">0xCD59</td></tr> <tr><td style="text-align: center;">Quick Stop</td><td style="text-align: center;">7</td><td style="text-align: center;">0x3155</td></tr> <tr><td style="text-align: center;">Quick Stop</td><td style="text-align: center;">10</td><td style="text-align: center;">0x19B4</td></tr> </tbody> </table>	Safety Digital Input (P424)	Safety SS1 max. time (P423)	Safety CRC (P499)	No function	0.1	0xDACB	Disable Voltage	0.1	0x971E	Quick Stop	0.1	0x4161	Quick Stop	0.2	0x6097	Quick Stop	0.3	0xBA5C	Quick Stop	0.5	0xF54D	Quick Stop	0.7	0x247E	Quick Stop	1	0x4664	Quick Stop	2	0x6E9D	Quick stop	3	0x3493	Quick Stop	5	0xCD59	Quick Stop	7	0x3155	Quick Stop	10	0x19B4
Safety Digital Input (P424)	Safety SS1 max. time (P423)	Safety CRC (P499)																																									
No function	0.1	0xDACB																																									
Disable Voltage	0.1	0x971E																																									
Quick Stop	0.1	0x4161																																									
Quick Stop	0.2	0x6097																																									
Quick Stop	0.3	0xBA5C																																									
Quick Stop	0.5	0xF54D																																									
Quick Stop	0.7	0x247E																																									
Quick Stop	1	0x4664																																									
Quick Stop	2	0x6E9D																																									
Quick stop	3	0x3493																																									
Quick Stop	5	0xCD59																																									
Quick Stop	7	0x3155																																									
Quick Stop	10	0x19B4																																									
<b>Note</b>	<p>If the safety functions are used, the parameter must be provided with password protection (<b>P498</b>).</p> <p>This parameter cannot be reset to the default value with Load Factory Setting (<b>P523</b>), but rather can only be reset manually.</p>																																										

### 5.2.3 Additional parameters

P506	Automatic fault acknowledgement		S
<b>Description</b>	Automatic acknowledgement of fault messages. (For details see  BU 0800)		
<b>Note</b>	Automatic error acknowledgement should not be used in association with a safety function.		
<b>Setting values</b>	0 = Detection is disabled		
	0	<b>No automatic</b> fault acknowledgement	When using the control terminals to control the FI, the error message is acknowledged by removing the enabling signal.
	1 ... 5	<b>Number</b> of permissible automatic fault acknowledgements within one mains-on cycle. After mains off and switch on again, the full amount is available again.	
	6	<b>Always</b> , a fault message will always be acknowledged automatically if the cause of the error is no longer present, see note.	
	7	<b>Quit disable</b> , acknowledgement is only possible using the OK / ENTER key or by switching off the mains. No acknowledgement is implemented by removing the enable!	
P559	DC Run-on time		S P
<b>Setting range</b>	0,00 ... 30,00 s		
<b>Factory setting</b>	{ 0.5 }		
<b>Description</b>	Completion of a braking action by temporary connection of a DC voltage to the motor connection terminals. (Details  BU 0800)		

## 6 Operating status messages

The majority of functions and operating data of the frequency inverter are continuously monitored and simultaneously compared with limit values. If a deviation is detected, the frequency inverter responds with a warning or an error message.

For basic information about this, please refer to the frequency inverter operating instructions.

All faults or reasons which result in a switch-on block of the frequency inverter and which are associated with STO functionality are listed below.

### Error messages

Display in the SimpleBox / ControlBox		Fault Text in the ParameterBox	Cause • Remedy
Group	Details in P700 [-01] / P701		
E004	4.0	<b>Module overcurrent</b>	Module error (short-term) <ul style="list-style-type: none"> <li>• Short circuit or earth fault at the FI output (motor cable or motor)</li> <li>• Optional braking resistor, defect/check</li> <li>• Optional motor choke, defect/check</li> </ul> Further notes <ul style="list-style-type: none"> <li>• Other causes of error:               <ul style="list-style-type: none"> <li>– Wrong size of braking resistor</li> <li>– Motor cable too long</li> <li>– Cable resistance too high or voltage at Safe Pulse Block too low</li> </ul> </li> <li>• Do not disconnect <b>P537!</b></li> <li>• <b>The error may significantly reduce the service life of the device or even destroy it</b></li> </ul>
E008	<b>8.0</b>	<b>Parameter loss</b> (maximum EEPROM value exceeded)	Error in EEPROM data <ul style="list-style-type: none"> <li>• Software version of the stored data set not compatible with the software version of the FI.</li> </ul> <b>NOTE:</b> Faulty parameters are automatically reloaded (factory setting). <ul style="list-style-type: none"> <li>• EMC interferences (see also E020)</li> </ul>
	<b>8.1</b>	<b>Inverter type incorrect</b>	<ul style="list-style-type: none"> <li>• EEPROM faulty</li> </ul>
	<b>8.2</b>	<b>External copy error</b> (ControlBox)	<ul style="list-style-type: none"> <li>• Check ControlBox for correct position</li> <li>• ControlBox EEPROM defective (<b>P550 = 1</b>)</li> </ul>
	<b>8.4</b>	<b>Internal EEPROM error</b> (Database version incorrect)	The configuration of the frequency inverter was not correctly identified. <ul style="list-style-type: none"> <li>• Switch mains voltage off and on again.</li> </ul>
	<b>8.7</b>	<b>EEPR copy not the same</b>	
E018	<b>18.0</b>	<b>Safety circuit (SafetyCirc)</b>	The Safe Pulse Block safety circuit has triggered during release.
	<b>18.5</b>	<b>Safety SS1</b>	The parameterised trigger time ( <b>P423</b> ) of the SS1-t functionality has expired. STO is triggered as the inverter still sends output pulses. This error cannot be acknowledged. Restart the frequency inverter.
	<b>18.6</b>	<b>Safety system</b>	A malfunction has occurred in the safety function. <ul style="list-style-type: none"> <li>• Restart the frequency inverter.</li> </ul>



## 6 Operating status messages

			<ul style="list-style-type: none"> <li>If the fault recurs, read out the extended error number in the parameter "Actual Operating Status (P700 [-04]) and contact Support.</li> </ul>
E110	110.0	Safety CRC	<p>A malfunction has occurred in the safety function.</p> <ul style="list-style-type: none"> <li>The CRC checksum does not match the safety parameters "Safety SS1 max. time" (P423) and "Safe Dig.input" (P424) and must be adjusted.</li> </ul>
	110.1	Safety CRC changed	The CRC checksum has been changed. The changes are only adopted after a restart.
	110.2	Safety w/oP497/Passw	<p>For use of the Safety Digital Input, the parameter password protection "Change safety passw." (P498) must be set.</p> <p>When changing the parameterisation of the safe input, the password in the "Safety password" parameter (P497) must be set.</p>

### Switch-on block messages

Display in the SimpleBox / ControlBox		Reason: Text in the ParameterBox	Cause • Remedy
Group	Details in P700 [-03]		
I000	0.1	Disable voltage from IO	<p>The input which is parameterised with the function Disable Voltage (P420/P480) is Low</p> <ul style="list-style-type: none"> <li>Set the input to High</li> <li>Check the signal cable (cable break)</li> </ul>
	0.2	Quick stop by IO	<p>The input which is parameterised with the Quick Stop function (P420/P480) is Low</p> <ul style="list-style-type: none"> <li>Set the input to High</li> <li>Check the signal cable (cable break)</li> </ul>
I018	18.0	STO active <sup>1)</sup>	The Safe Pulse Block safety circuit has been triggered. A connected motor does not produce any torque.

1) Indication of operating mode (message) on the *ParameterBox* or virtual operating unit of the *NORD CON-Software*: "Not ready"

### Status information

It is possible to access status information by means of the *ParameterBox*, *ControlBox* or a field bus. This information is **not fail-safe**. It is for information only.

The status of the Safe Pulse Block and the digital inputs and outputs can be accessed via the information parameters and if necessary by means of the status word with communication via a field bus.

In order to be able to query the reaction of the Safe Pulse Block, the digital output, a Bus Out bit or a free bit of the status word (Bit 10 or Bit 13) must be assigned the function 39 ("STO inactive"). The state of these bits can be read out via "State of relays" (P711), "Status word" (P741 [-01]) or "Bus Out Bits" (P741 [-07]) parameter, or can be transferred via the bus protocol.

A digital output can be used to indicate the status of the Safe Pulse Block. It should be noted that this status indication is not fail-safe.

When using the control terminals to control the frequency inverter, the error message is acknowledged by removing the enabling signal, see P506.

## 7 Additional information

### 7.1 Protective switching devices

The safety switching device used for the intended purpose, as well as all additional components required to implement a safety function, must fulfil the requirements of the special application in accordance with the risk analysis.

The switching device outputs must fulfil the following basic conditions.

#### 7.1.1 Output voltage of the protective switching devices

The stated voltage must be connected to the input terminals of the frequency inverter. I.e. the voltage drop in the used cable must also be taken into account.

##### Mechanical protective switching device

24 V  $\pm$  25 % (18 V...30 V) for the Safe Pulse Block

24 V -37.5 % + 25 % (15 V...30 V) for the Safety Digital Input

##### Electronic protective switching device with OSSD outputs

24 V - 20 % / + 25 % (19.2 V...30 V) for the Safe Pulse Block

24 V -37.5 % + 25 % (15 V...30 V) for the Safety Digital Input

#### 7.1.2 Switching capacity and current load

The safety outputs of the switching devices must be designed for the loads stated below.

Load per connected frequency inverter	VIS1_24V (M3_4)	VIS2_24V (M3_2)
Continuous current (average value)	See below	See below
Switch-on current	$\leq 70$ mA for $t \leq 4$ ms	$\leq 700$ mA for $t \leq 2.5$ ms
Support capacitance (downstream of inverse polarity protection)	approx. 5 $\mu$ F	approx. 30 $\mu$ F
Peak current after an OSSD test pulse (periodic)	$\leq 70$ mA for $t \leq 1$ ms	$\leq 700$ mA for $t \leq 1$ ms

The following details for average input currents relate to the voltage directly at the input terminals. I.e. if necessary, the voltage drops in the cable and the tolerance of the source must be taken into consideration. The stated currents are not typical values but rather form the basis for dimensioning the protective switching device.

##### Average input current:

	Input voltage VIS1_24 V						
	18 V	20 V	22 V	24 V	26 V	28 V	30 V
	21 mA	22 mA	23 mA	24 mA	25 mA	26 mA	27 mA
Application class	Input voltage VIS2_24 V						
	18 V	20 V	22 V	24 V	26 V	28 V	30 V
A	101 mA	95 mA	91 mA	88 mA	86 mA	85 mA	84 mA
B	114 mA	107 mA	101 mA	97 mA	94 mA	92 mA	91 mA
C	124 mA	116 mA	109 mA	105 mA	101 mA	99 mA	97 mA

** Information****Increased current on switch-on or after a test pulse from an OSSD**

Due to the support capacitors of the safe shut-down method, there is an increased current consumption on switch-on and after a test pulse from an OSSD. The Safe Pulse Block is equipped with an active current limiter in order to reduce the load on safety outputs to a minimum, (see chapter 8.1 "Safe Pulse Block and Safety Digital Input").

---

### 7.1.3 OSSD outputs, test pulses

The OSSD signal must satisfy the following requirements:

- $D \geq 90\%$  (duty, switch-on ratio)
- Double pulses are permissible if the falling edges of the pulses are at least  $2 * t_{OSSD}$  apart and the condition for D is fulfilled, see example 1 and example 2.
- The width of the test pulse should be within the range  $0.2 \text{ ms} \leq t_{OSSD} \leq 0.5 \text{ ms}$ . The maximum width of the test pulse depends on the application class:

Application class	A	B	C
$t_{OSSD, \text{max}}$	1000 $\mu\text{s}$	1000 $\mu\text{s}$	900 $\mu\text{s}$

- Depending on the application class and the length of the test pulse, it may be necessary to increase the minimum input voltage of the protective switching device  $V_{IS\_24V, \text{min}}$ .

Voltage correction of long OSSD test pulses

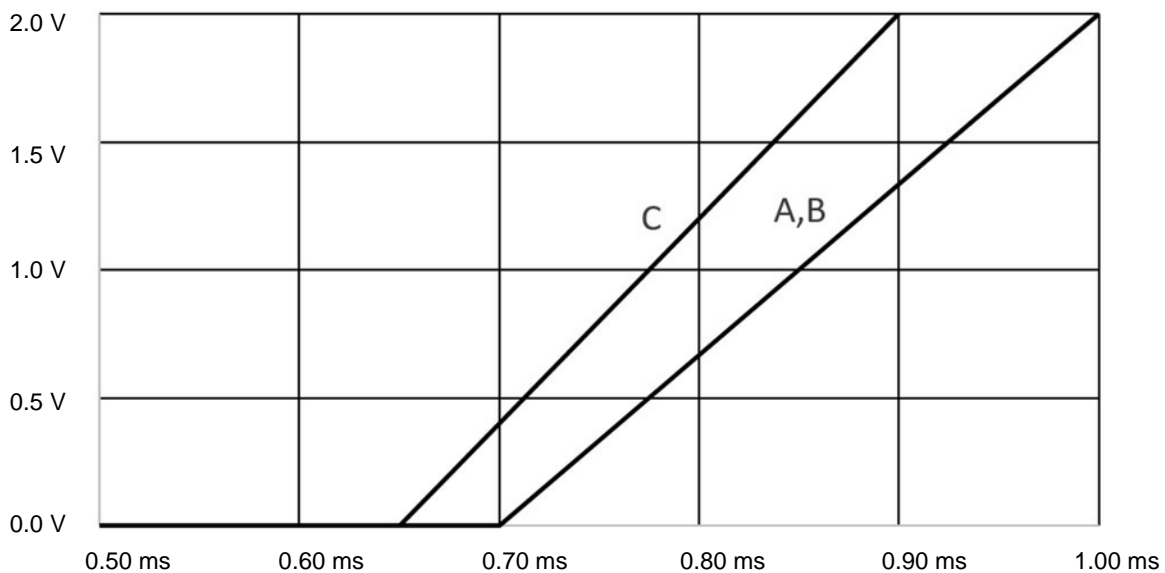

This voltage correction is cumulative with other corrections, see example 3.

#### Example 1

After a test pulse with duration  $t_{OSSD}$ , the supply voltage is connected for at least  $9 * t_{OSSD}$ .

#### Example 2

Permissible test pulses for an OSSD

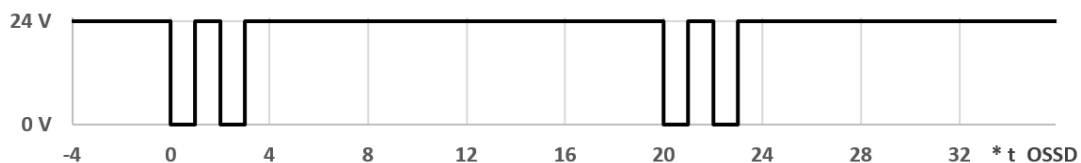

- First test pulse with width  $t_{OSSD}$ .
- The supply voltage is present for the time  $1 * t_{OSSD}$
- Second test pulse with width  $t_{OSSD}$ .
- The supply voltage is present for at least  $17 * t_{OSSD}$ .

**Example 3**

In  3.3.2.2 "Multiple device operation", the example for application class B and a minimum input voltage of  $V_{24V, \min} = 21.2$  was determined. If in this example, the width of the test pulse is  $t_{OSSD} = 0.80$  ms, the minimum input voltage is increased by a further 0.7 V to  $V_{24V, \min} = 21.9$ . If in this example a 24 V voltage source with a tolerance of 10 % is used ( $V_{Q, \min} = 21.6$  V), this would be too small, i.e. a source with a smaller tolerance, a shorter test pulse width to the OSSD, or a larger cable cross-section is required.

**7.2 Safety categories****7.2.1 IEC 60204-1:2016**

(German version EN 60204-1:2018)

The requirements of category 0 and category 1 stop functions can be fulfilled by the Safe Pulse Block. Controlled stopping of a category 1 stop function is not fail-safe via the standard functions of the frequency inverter. The switch-over to the category 0 stop function is fail-safe.

**7.2.2 IEC 61800-5-2:2016**

(German version EN 61800-5-2:2017)

The requirements for the Safe Torque Off (STO) function and the safety integrity level SIL 3 can be fulfilled with the safe shut-down method Safe Pulse Block.

The requirements for the "Safe Stop 1 time-controlled" (SS1-t) function and the safety integrity level SIL 2 can be met with the combination of Safe Pulse Block and Safety Digital Input.

With the SS1-t function, there is no safe monitoring of motor speed reduction or motor speed by the frequency inverter. If a risk analysis shows that monitoring is necessary, this must be performed by an external safety control unit. The solution for the SS1-t function described in the examples corresponds to characteristics as per IEC 61800-5-2:2016, Section 4.2.3.3, Paragraph c) "Triggering of motor speed reduction and triggering of the STO function after an application-specific time delay". The motor speed reduction is carried out via the standard functionality of the frequency inverter and is not fail-safe. Switchover to the STO function is carried out as fail-safe via an external safety control unit, e.g. a protective switching device.

I.e. triggering of the motor speed reduction via the Safety Digital Input can meet the safety integrity level SIL 2. The externally performed transition to the STO function can meet the safety integrity level SIL 3.

NOTE: Controlled stopping by the SS1-t function can fail without detection. Because of this, the SS1-t function cannot be used if such failure could cause a hazardous situation in the end application.

The fault response function of the Safety Digital Input is the STO function. If a fault is detected in the Safety Digital Input during motor speed reduction, the motor outputs are switched off by the software. This behaviour corresponds to the STO function.

**7.2.3 IEC 61508:2010**

(German version EN 61508:2010)

The shut-down method Safe Pulse Block for implementing the STO safety function meets the requirements for safety level SIL 3. The Safety Digital Input for triggering motor braking for the SS1-t function meets the requirements for safety level SIL 2,  7.2.2 "IEC 61800-5-2:2016".

#### 7.2.4 ISO 13849-1:2015

(German version EN ISO 13849-1:2016)

The shut-down method Safe Pulse Block for implementation of the STO safety function meets the requirements of Performance Level e and category 4.

The Safety Digital Input for triggering motor braking for the SS1-t function meets the requirements of Performance Level d and category 2.

---

#### Information

##### **Evaluation of safety function**

The values stated in the technical data only refer to the stated inputs or shut-down methods.

The components which are additionally required for the implementation of a safety function, such as protective switching device, emergency stop button, etc. must also be taken into account for the evaluation of the safety function. The resulting safety-relevant data can be significantly influenced by these components.

---

## 8 Technical Data



The Technical Data from the frequency inverter manual (BU 0800) apply!

In deviation from this:

Function	Specification
<b>Max. installation altitude above sea level</b>	≤ 2000 m

The following technical data also apply.

### 8.1 Safe Pulse Block and Safety Digital Input

	Safe Pulse Block	Safety Digital Input
<b>Input voltage</b>	+24 V ±25% (18 V ... 30 V)	+24 V -37.5% +25% (15 V ... 30 V)
<b>Operation with OSSD</b>	-20% ... +25% (19.2 V ... 30 V)	+24 V -37.5% +25% (15 V ... 30 V)
<b>High level</b>	≥ 18 V	≥ 15 V
<b>Low level</b>	≤ 3 V	≤ 3 V
<b>Current consumption (average value)</b>	Depending on the input voltage and application class (inverter type and pulse frequency) see 7.1.2 "Switching capacity and current load"	≤ 10 mA
<b>Peak current (peak, when switching on or on the OSSD)</b>	VIS1_24V: ≤ 70 mA VIS2_24V: ≤ 700 mA	≤ 25 mA
<b>Input resistance</b>	– –	Low level: 10 kΩ High level: 3 ... 5 kΩ
<b>Input capacitance</b>	VIS1_24V: approx. 5 μF VIS2_24V: approx. 30 μF (downstream of inverse polarity protection)	approx. 10 nF
<b>Cable length</b>	≤100 m (shielded for compliance with EMC requirements)	
<b>Cable capacitance</b>	≤ 20 nF per connected frequency inverter (≤ 4 nF * t <sub>OSSD</sub> / 0.1 ms for t <sub>OSSD</sub> ≤ 500 μs)	
<b>Requirements for OSSDs</b>		
Test pulse width	200 μs ≤ t <sub>OSSD</sub> ≤ 500 μs,  3.3.2 "Operation with OSSD",  7.1.3 "OSSD outputs, test pulses"	
Duty (High level)	≥ 90 %	
Time between double pulses (time between falling edges)	≥ 2* t <sub>OSSD</sub> (note the duty factor)	
<b>Switch-on delay</b> (time between input change from Low to High level and the time at which enabling of the frequency inverter is possible.)	≤25 ms	≤15 ms
<b>Reaction time</b> (time between input change from High to Low level and triggering of the safety sub-function.)	≤140 ms	≤10 ms

<b>Cycle time</b> (time between two identical edges at the input)	≥1 s	
<b>Fault response time</b> (The time between detection of a fault and triggering of the fault response function.)		≤35 ms
<b>Fault response function</b>		Inverter shut-down (behaviour as for STO)
<b>Priority</b>	Highest	Low
<b>Source of failure rates</b>	SN 29500	
<b>Conformant object</b>	Type B	
<b>Hardware error tolerance</b>	HFT 0	
<b>Proportion of safe failures</b>	SFF = 100%	SFF = 97.89%
<b>Probability of a hazardous failure per hour</b>	PFH = 0	PFH = 14.04 FIT
<b>Mean time until hazardous failure</b>	MTTF <sub>d</sub> = "High" (> 100 years)	
<b>Diagnostic coverage level</b>	cannot be determined (PFH = 0)	DC = 91.55% ("average")
<b>Safety integrity level</b> (as per IEC 61800-5-2:2016 and IEC 61508:2010)	SIL 3	SIL 2
<b>Category</b> (as per EN ISO 13849-1:2016)	Category 4	Category 2
<b>Performance Level</b> (as per EN ISO 13849-1:2016)	PL e	PL d
<b>Proof test interval</b>	TM = 20 years (duration of use, "Mission Time")	



## 9 Appendix

### 9.1 Maintenance information

The maintenance information from the frequency inverter manual (BU 0800) apply.

The information on long-term storage also apply for the Safe Pulse Block.

Thus, the Pulse Block must be supplied with a voltage of **24 V DC** at least **1 x per year for 60 minutes** in order to maintain its function and to prevent damage to the Safe Pulse Block.

### 9.2 Repair information

In order to keep repair times as short as possible, please state the reason for returning the device and at least one contact in case of queries.

In case of repair, please send the device to the following address:

#### **NORD Electronic DRIVESYSTEMS GmbH**

Tjüchkampstraße 37  
26606 Aurich

---

#### **Information**

##### **Third party accessories**

Getriebebau NORD GmbH & Co. KG cannot accept liability for third party accessories if these are returned with the device.

---

#### **Information**

##### **Accompanying document**

Please complete the accompanying document for the return. This can be found on our homepage [www.nord.com](http://www.nord.com) or directly under the link [Warenbegleitschein](#)

---

In case of queries about repairs please contact:

#### **Getriebebau NORD GmbH & Co. KG**

Tel.: +49 (0) 45 32/ 289-2515

Fax: +49 (0) 45 32 / 289-2555

### 9.3 Service and commissioning information

In case of problems, e.g. during commissioning, please contact our service department:

Tel.: +49 4532 289-2125

Our service is available to you at all times (24/7) and can support you the best if you have the following device information and accessories available:

- Type designation,
- Serial number,
- Firmware version.

### 9.4 Documents and software

Documents and software can be downloaded from our website [www.nord.com](http://www.nord.com).

#### Other applicable documents and further information

Documentation	Contents
<a href="#">BU_0800</a>	Manual for frequency inverter NORDAC ON (SK 3xxP)
<a href="#">BU_0000</a>	Manual for use of NORDCON software
<a href="#">BU_0040</a>	Manual for use of NORD ParameterBoxes

#### Software

Software	Description
<a href="#">NORDCON</a>	Parameterisation and diagnostic software

## 9.5 Abbreviations

- **BR** Braking resistor
- **DIN** Digital input
- **DOUT** Digital output
- **EMC** Electromagnetic compatibility
- **FI** Frequency inverter
- **GND** Ground
- **OSSD** Output Signal Switching Device
- **P** Parameter set dependent parameter, i.e. a parameter which can be assigned different functions or values in each of the 4 parameter sets of the frequency inverter.
- **PDS(SR)** Power Drive Systems (Safety Related) → Power drive systems with integrated safety functions.
- **S** Supervisor parameter, i.e. a parameter which is only visible if the correct Supervisor Code is entered in parameter **P003**
- **SS1** Safe Stop 1
- **STO** Safe Torque Off, torque safely switched off
- **V<sub>24V,min</sub>** Minimum input voltage of the protective switching device

## Key word index

"	
"Parameter.....	40
<b>A</b>	
Accompanying document .....	49
Auto. Fault acknowledgement (P506) .....	39
Automatic starting (P428) .....	36
<b>C</b>	
Change safety passw. (P498) .....	37
Commissioning .....	29
SS1-t .....	29
STO .....	29
<b>D</b>	
DC Run-on time (P559) .....	39
Digital output function (P434) .....	37
Documents	
Other applicable .....	50
<b>E</b>	
EMC .....	28
Example .....	27
SS1-t .....	18
STO .....	16
<b>F</b>	
Funct-BusIO Out Bits (P481) .....	37
<b>M</b>	
Mechanical brake .....	14
Messages	
Fault .....	40
Operating state .....	40
<b>O</b>	
OSSD .....	24, 27, 42, 47
<b>P</b>	
Parameterisation of the safe digital input .....	33
Parameters .....	33
Protective switching devices .....	42
<b>Q</b>	
Quick stop time (P426) .....	36
<b>R</b>	
Repairs .....	49
Re-start block .....	19
Returns .....	49
<b>S</b>	
Safe Dig.input (P424) .....	35
Safe Pulse Block .....	24
Example .....	27
OSSD .....	24, 27, 47
Safe shut-down method	
Safe Pulse Block .....	24
Safety CRC (P499) .....	38
Safety functions	
Safe torque switch-off .....	14
STO .....	14
Safety password (P497) .....	37
Safety SS1 max. time (P423) .....	35
Software .....	50
SS1-t	
Commissioning .....	29
Example .....	18
Standard	
IEC 60204-1 .....	45
IEC 61508 .....	45
IEC 61800-5-2 .....	45
ISO 13849-1 .....	46
STO .....	14
Commissioning .....	29
Example .....	16
<b>T</b>	
Technical Data .....	47
<b>V</b>	
Validation .....	32







Headquarters  
Getriebebau NORD GmbH & Co. KG  
Getriebebau-Nord-Str. 1  
22941 Bargteheide, Deutschland  
T: +49 45 32 / 289 0  
F: +49 45 32 / 289 22 53  
info@nord.com